

Controller description

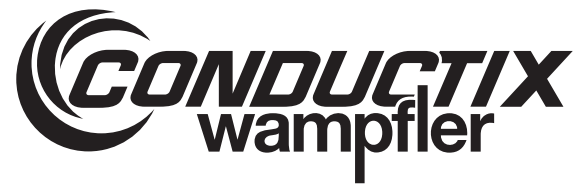

ST-83x / ST-84x

Vehicle controller



Conductix-Wampfler Automation GmbH
Handelshof 16 A
14478 Potsdam
Germany
Telephone: +49 331 887344-0
Fax: +49 331 887344-19
Email: info.potsdam@conductix.com
Internet: www.conductix.com
Translation of the original
STB_0006, 5, en_GB

Table of contents

1	Information on the description	7
1.1	Revision history	7
1.2	How to use and store the description	7
1.3	Applicable documents	8
1.4	Copyright protection	8
1.5	Illustrations	8
1.6	Brands	8
2	Warranty and liability	9
2.1	Warranty	9
2.2	Limitation of liability	9
3	Safety instructions	11
3.1	Warning concept	11
3.1.1	Arrangement of warnings	11
3.1.2	Structure of warnings	11
3.1.3	Signal words	12
3.1.4	Hazard symbols	12
3.1.5	Suggestions and recommendations	13
3.2	Intended use	14
3.3	Foreseeable incorrect use	14
3.4	Modifications and alterations	14
3.5	Responsibility of the operator	15
3.6	Personnel and qualifications	16
3.7	Special hazards	18
3.8	Safety instructions for the system operator and manufacturer	19
3.9	Safety devices	20
3.10	Safe isolation	21
4	Product description	23
4.1	Overview of functions	23
4.2	Structure	24
4.3	Model name and type label	25
4.3.1	Model name	25
4.3.2	Type label	25
5	Transport and storage	27
5.1	Transport	27
5.2	Transport inspection	27
5.3	Storage	28

6	Mechanical installation	29
6.1	Open spaces and cooling.....	32
6.2	Installation location and position.....	33
6.3	Installation.....	34
7	Electrical installation	37
7.1	Notes about electrical installation.....	40
7.1.1	Residual current circuit breaker and mains fusing.....	40
7.1.2	Electromagnetic compatibility.....	41
7.1.3	Control system motor output.....	42
7.1.4	Protective measures.....	43
7.2	Connecting the electrical parts of the control system.....	44
7.3	Electrical connections.....	45
7.3.1	Connection overview.....	45
7.3.2	X1 - Supply.....	46
7.3.3	X2 - Motor.....	48
7.3.4	X13, X14, X15 sensors.....	49
7.4	Earthing the control system.....	50
8	Commissioning	51
8.1	Notes about commissioning.....	55
8.2	Commissioning procedure.....	56
8.3	Switch on control system.....	56
8.4	Assign control system parameters.....	57
8.4.1	Vehicle parameters and configuration switches.....	58
8.4.1.1	Creating and saving parameters and configuration switches.....	58
8.4.1.2	Transferring parameters and configuration switches.....	60
8.4.2	Vehicle tables.....	60
8.4.2.1	Creating and saving vehicle tables.....	61
8.4.2.2	Transferring vehicle tables.....	62
8.5	Test control system.....	63
8.5.1	Test – motor functions.....	64
8.5.2	Test – Sensors and peripherals.....	66
8.5.3	Test – Communication.....	67
8.6	Optimise settings.....	69
9	Operation	71
9.1	Operating modes.....	74
9.2	Switching the control system on and off.....	75

9.2.1	Switch on control system.....	75
9.2.2	Switches the control system off.....	75
9.3	Display with infra-red interface.....	76
9.4	Displays.....	77
9.4.1	Operation displays.....	77
9.4.2	Display modes.....	78
9.4.2.1	Creating/modifying display modes.....	78
9.4.2.2	Calculating and evaluating hexadecimal values.....	79
9.5	Vehicle remote control.....	80
9.5.1	Changing operating mode.....	81
9.5.2	Moving the vehicle manually.....	82
10	Faults.....	85
10.1	Error indicators and messages.....	85
10.2	Fault reset.....	87
10.2.1	Self-acknowledging errors.....	87
10.2.2	Errors to be acknowledged manually.....	88
11	Service and maintenance.....	91
11.1	Maintenance and cleaning.....	91
11.1.1	Maintenance.....	91
11.1.2	Cleaning.....	92
11.2	Removing / replacing the control system.....	93
11.2.1	Control system removal.....	94
11.2.2	Control system installation.....	94
11.3	Repairing the control system.....	95
12	Disposal.....	97
12.1	Information on disposal and environmental regulations.....	97
13	Technical Data.....	99
13.1	Device.....	99
13.2	Input data.....	101
13.3	Output data.....	102
13.4	Display with infra-red interface.....	103
13.5	Cable lengths and specifications.....	103
13.6	Approvals and standards.....	103
13.7	Device drawing.....	105
14	Customer service and addresses.....	107
15	Index.....	109

1 Information on the description

1.1 Revision history

We reserve the right to make changes to the information present in this document, which result from our constant effort to improve our products.

Version	Date	Comment/reason for change
1	01.2021	Basic version
2	09.2021	Chapter ' <i>Optimise settings</i> ' updated
3	11.2021	Chapter ' <i>Cable lengths and specifications</i> ' updated
4	12.2022	Conductix-Wampfler Automation GmbH
5	04.2023	TÜV certification added

1.2 How to use and store the description

This documentation forms part of the product. It contains important information and notes on using the product. It affects:

- Mechanical and electrical installation
- Commissioning
- Operation
- Maintenance and service

To work safely with the product, it is necessary to observe the safety notes and action instructions. All persons working with the product must have understood the user information in this description and apply it conscientiously. The operator must fulfil his duty of care and ensure that all persons working with the product have read and understood the user information and are implementing it.

This description forms part of the product and must be accessible to all persons working with the product at all times.

1.3 Applicable documents

The documents contained in the project documentation also apply if the device / system is part of a project-specific system plan.

The following documents are considered part of this description. They are located at the end of this description or they are included as an extra description in the scope of delivery.

- Connection diagram ANS
- Device drawing GER
- Software description BV

Connected devices and components are covered by their own documentation.

1.4 Copyright protection

The contents, texts, drawings, pictures and other illustrations of this description are protected by copyright and subject to intellectual property rights. Any misuse is punishable by law.

Reproduction in whole or in part of this description is only permitted within the limits of the legal provisions of the copyright law. Any modification or shortening of the text is prohibited without the explicit written consent of Conductix-Wampfler Automation GmbH.

1.5 Illustrations

The illustrations that accompany this description have been purposely selected. They are provided for basic understanding and may differ from the actual design. No claims shall be accepted for possible discrepancies.

1.6 Brands

The popular names, trade names, production descriptions, etc. used in this description may constitute trademarks even without special designations and as such may be subject to legal requirements.

2 Warranty and liability

2.1 Warranty

The warranty only covers production defects and faulty components.

The manufacturer assumes no responsibility for damages caused during transport or unpacking. In no case and under no circumstances will the manufacturer be liable for defects or damages caused by misuse, incorrect installation or inadequate environmental conditions or from dust or corrosive substances.

Consequential damages are excluded from the warranty.

Should you have further questions regarding the warranty, please contact the supplier.

2.2 Limitation of liability

All information and notes in this description have been compiled taking into account the applicable standards and regulations, the state of the art and our many years of knowledge and experience.

Conductix-Wampfler Automation GmbH assumes no liability for damage and malfunctions during operation due to:

- Failure to comply with the description
- Non-intended use
- Use by untrained personnel
- Unauthorised alteration or modification
- Use of the product, despite negative transport inspection

Furthermore, Conductix-Wampfler Automation GmbH's warranty obligation will cease to exist in case of a failure to comply with the description.

3 Safety instructions

This section contains information on all safety aspects for optimum protection of personnel and for safe operation without malfunctions.

To prevent dangers, these notes must be read and followed by personnel. Only then can safe operation be guaranteed.

Of course, all legally applicable general safety and accident prevention regulations must be complied with.

Conductix-Wampfler Automation GmbH assumes no liability for damage or accidents that were caused by non-observance of these safety notes.

3.1 Warning concept

This description contains notes that must be observed for your own personal safety and to avoid property damage. Notes regarding your personal safety are highlighted by a warning triangle; notes regarding property damage do not have a warning triangle.

When several hazard levels occur, the warning always refers to the highest level. If a warning of injury to persons is indicated with a warning triangle, the same warning might include an additional warning of property damage.

3.1.1 Arrangement of warnings

If warnings refer to an entire section, they are placed at the beginning of the section (e.g. chapter start).







If warnings refer to a specific action instruction, they are placed in front of the respective action instruction.

3.1.2 Structure of warnings

- **SIGNAL WORD**
- ↳ Type of danger and its source
- ↳ Possible consequences, if not observed
- ↳ Danger avoidance measures
- ↳ Preventive measures

3.1.3 Signal words







Warnings are indicated using signal words based on hazard levels.

Signal word	Meaning
 	This combination of symbol and signal word indicates a possible dangerous situation that can result in death or serious injury if it is not avoided.
 	This combination of symbol and signal word indicates a possible dangerous situation that can result in minor injury if it is not avoided.
 	This combination of symbol and signal word indicates a possible dangerous situation that can result in material damage if it is not avoided.

3.1.4 Hazard symbols

Warnings of the groups 'danger' and 'warning' are content-based. They are presented with clear danger symbols.

Warnings of the 'caution' group do not have a specific danger symbol.

Warning signs	Type of danger
	Warning – automatic start-up.
	Warning - danger of crushing.
	Warning – high-voltage.
	Warning – danger of falling.
	Warning – falling objects.
	Warning – hot surface.

Warning signs**Type of danger**

Warning – danger zone.

3.1.5 Suggestions and recommendations

This symbol indicates important information to help you handle the product.

3.2 Intended use

The control system has been designed and constructed exclusively for the intended use described below.

Vehicle control systems type ST-83x/ST-84x of the "Series 8" series of control systems are compact, programmable Triac control systems. These control systems are intended for the operation and control of pole-changing asynchronous motors in industrial and commercial systems.

Electrical systems or machines must comply with the EU Directive 2006/42/EC (Machinery Directive) or the DIN EN 60204-1 standard if they are to be fitted with Conductix/LJU vehicle control systems. Intended operation is only permitted in compliance with the EMC Directive (2014/30/EU EMC).

3.3 Foreseeable incorrect use

Any use that goes beyond this description is forbidden.



⚠ WARNING!

Hazard from non-intended use!

Any use of the control system other than and/or beyond the one intended can cause hazardous situations.

- Only use the control system for its intended purpose.
- Only connect motors that are suitable for operation with the control system.
- Do not connect any other loads.
- It is essential that you comply with all specifications regarding the technical data and the permitted conditions at the place of use.
- Do not use the control system in potentially explosive atmospheres.
- Do not operate the control system in environments with harmful oils, gases, vapours, dusts, radiation, etc.
- Do not use the control system for the transportation of people or animals.

3.4 Modifications and alterations

For the purpose of avoiding hazards and for ensuring optimum performance, any modifications, additions, or alterations to the controller require Conductix-Wampfler Automation GmbH's express consent.



⚠ WARNING!

Injury hazard from structural modifications!

Unauthorised technical modifications can cause substantial bodily harm or material damage.

- Replace faulty control systems.
- A faulty control system should only be replaced by an identical control system.

3.5 Responsibility of the operator

The control system is used in an industrial environment. The operator of the control system is therefore subject to statutory obligations regarding work safety.

In addition to the work safety instructions in this description, the safety, accident prevention and environmental regulations applicable to the area where the control system is used must be complied with.

The following applies in particular:

- The operator must become familiar with the applicable work safety regulations and must also determine the dangers that are posed by the particular work conditions at the location where the control system is to be used by means of a risk assessment. This must be realised in the form of operating instructions for operating the control system.
- This description must be kept within easy reach of the control system be accessible to those persons charged with working both on and with the control system at all times.
- The specifications of the description must be adhered to fully and unconditionally.
- The control system may only be operated when in a perfect and operationally safe condition. The control system must be checked for detectable defects prior to each time it is put into service.
- The system operator must ensure that the responsibilities for activities on the system are unambiguously defined and only adequately qualified personnel familiar with the operating and safety regulations are working on and with the control system.

3.6 Personnel and qualifications

The product / system belonging to this description may only be handled by personnel qualified for the respective task. This is done taking into account the descriptions associated with the particular task, especially the safety and warning information contained therein.

Due to their training and experience, qualified personnel are able to recognize risks and avoid possible hazards when dealing with this product / system.



⚠ WARNING!

Injury hazard from insufficient qualification!

Improper handling can cause substantial bodily harm or material damage.

Installation and commissioning



⚠ WARNING!

Danger posed by faulty installation and initial commissioning.

The installation and initial commissioning of the control system require trained specialist personnel with sufficient experience. Faults with the installation may lead to potentially fatal situations or considerable material damage.

- Have installation and initial commissioning performed exclusively by employees of the manufacturer or by trained personnel authorised by it.
- Works on electric components may only be carried out by qualified electricians or persons instructed and supervised by a qualified electrician in accordance with the electro-technical regulations.
- Before carrying out any kind of work on the controller, make sure it is de-energised and secured against accidental reconnection.
- Prior to commissioning, ensure that all safety equipment is installed and functioning properly.
- Prior to commissioning, ensure that parameter assignment on the control system has been performed correctly in accordance with the electrical and mechanical conditions of the system.

Electrical work



⚠ WARNING!

Electrical hazard!

Contact with live parts poses an immediate danger to life. The touching of open terminals and wires may lead to death or serious injury.

- Only qualified electricians are allowed to work on electrical system components, devices or equipment.
- De-energise system parts to work on them.
- Check the de-energised state of system parts disconnected from the mains voltage before starting to work on them.
- Do not open covers during operation.
- Call on the assistance of a second person who can actuate the EMERGENCY-STOP mechanism or the main switch in an emergency, when working on live parts.
- Some components in the system may still be live even after the system has been switched off. They are specially designated. Ensure to follow the notes on their designation when working on these components!
- Use only insulated tools to work on the electric system!

Operation and maintenance

The operation and maintenance of the control system must only be performed by trained and qualified personnel. Staff undergoing instruction and training are allowed to perform activities on and with the control system under the constant supervision of a trained and qualified individual.

3.7 Special hazards



⚠ WARNING!

Live parts

Contact with live parts poses an immediate danger to life. Damage to the insulation or individual components can be life-threatening.

- In case of damage to the insulation, turn off power supply immediately.
- Check devices and connected components regularly. Any loose connections, damaged cables and insulations as well as all damages that could pose a risk to safety must be rectified immediately. Any faulty protection against accidental contact must be repaired immediately.
- Works on electric components may only be carried out by qualified electricians or persons instructed and supervised by a qualified electrician in accordance with the electro-technical regulations.
- Before carrying out any kind of work on the control system, make sure it is de-energised and secured against accidental reconnection.
- Always use insulated tools.



⚠ WARNING!

Danger from external voltage after switching off the control system

Depending on the function and installation, it is possible that external voltages, which are not switched off by the on/off switch of the control system, are fed into the control system. Contact with live parts poses an immediate danger to life.

Disconnect the power supply safely:

- Disconnect the system from the power supply.
- Disconnect the current collectors from the busbars.

All poles of the power supply must be able to be shut down and protected against being switched on again. Installation of a main switch by the system operator or system manufacturer.

**⚠ WARNING!****Electrical voltage after shutdown**

Some components of the vehicle control systems, especially the intermediate circuit of the control system's switching power supply unit, may still carry a voltage after shut-down. Work on these components may only be carried out after the intermediate circuit has discharged!

- **Waiting time after disconnection from power:** at least 10 minutes

**⚠ WARNING!****Automatic start-up of the system**

Death or serious injuries!

If the vehicle control system is in automatic mode or is being switched to automatic mode, an automatic start-up of the system is to be expected at any time.

3.8 Safety instructions for the system operator and manufacturer

**⚠ WARNING!****On/off switch of the control system**

The on/off switch of the control system is not a component for bringing the control system to a safe stop. The on/off switch switches off the control system at all poles, but can be switched on again at any time. After switching on again, the control system can start in automatic mode. Automatic start-up of the system can lead to death and serious injury.

- Implement safe control functions within your system controller, if your security concept demands safe functions.
- Make sure that only authorised persons switch the control system back on.

**⚠ WARNING!****Unsafe control functions**

Risk of crushing limbs, catching and dragging of loose items of clothing due to moving machine parts.

- Implement safe control functions within your system controller, if your security concept demands safe functions.

**⚠ WARNING!****Safety note for system integration****Warning about falling parts**

Depending on the control by higher-level sensors, shutting down the control system causes the drive to come to an immediate standstill and the motor brake to engage.

- Take this into account when performing your risk assessment for system integration.

3.9 Safety devices

**⚠ WARNING!****Danger to life from non-functioning safety devices!**

Security devices ensure a maximum degree of safety during operation. Never override safety devices, even if they obstruct work processes. Safety can only be guaranteed if the safety devices are intact.

- Before starting work, check whether the safety devices are fully functional and connected properly to the controller.
- Report any faulty safety devices immediately.
- Bring vehicles with defective safety equipment to a standstill immediately.
- Get safety devices repaired immediately.

**Connected safety equipment**

For further detailed information about which safety devices are connected to the controller, please refer to the connection diagram of the controller.

3.10 Safe isolation

The vehicle controller meets all the requirements of EN 61800-5-1 and provides reliable isolation of electronic and power connections.

To ensure safe isolation, all connected electrical circuits must meet the requirements for safe isolation.

4 Product description

4.1 Overview of functions

ST-83x/ST-84x vehicle control systems are compact, programmable Triac control systems for controlling pole-changing motors for one axle.

Command systems

Command specifications for the control system can be implemented using the following command systems:

- PCM system
- Half wave control system
- Z-stop (block position control system with Z-skip)

Function

The control system constantly evaluates the travel commands arriving from the PLC via a control rail and determines the travel behaviour of the vehicle by linking them to the current parameter setting of the control system. In this way, different signals in different areas of the system can be used to achieve the appropriate travel behaviour of the vehicle (e.g. slow positioning speed, high transport speed, brake release, etc.).

The separate motor windings are controlled via Triacs. The brake is controlled by means of an IGBT.

The drive motor is driven as long as the control system detects a valid signal and no stop command is present.

Stop commands can be generated by connected sensors (e.g. approach sensor/ultrasonic sensor) or also by a Z-skip in a Z-stop system. If a stop command is detected, the control system brings the vehicle to a standstill. After the stop command is cancelled, the control system starts up again according to the set delay time.



Virtually judder-free acceleration and braking of the vehicle are possible by varying the operating parameters.

Sensors

External sensors connected to the control system are monitored and evaluated independently by the control system. The necessary configuration is programmable.

Parametrisation and remote control

Application software and operating parameters can be transmitted via infra-red to the control system by means of the MU-705 manual programming device.

For functions such as the manual moving of the vehicle, the control system can be remotely controlled using the infra-red hand-held remote control.

Monitoring

The control system monitors basic sources of errors on the vehicle and, in the event of a malfunction, it issues a differentiated message on the 4-digit, 7-segment display in the vehicle control system and, if used, it also sends a collective error message to the higher-level system control (PLC) via the signal rail.

4.2 Structure

The vehicle control system is designed as a compact device. The following illustration shows the most important parts of the vehicle control system.

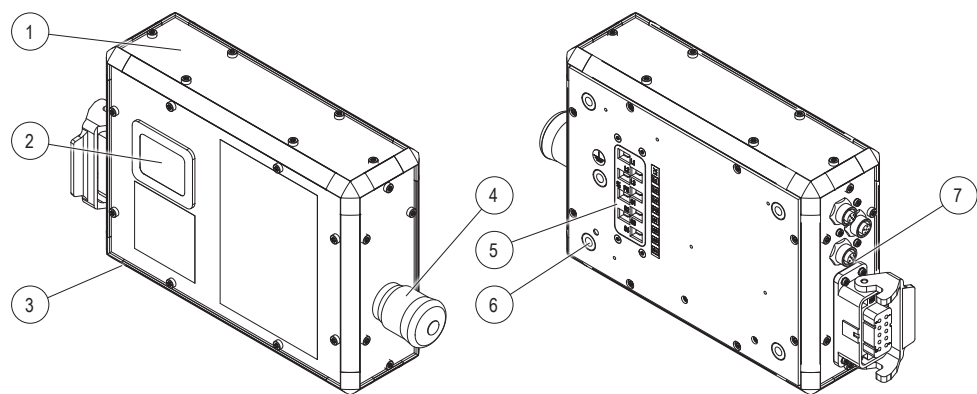

Fig. 1: Control system layout

- 1 Housing with internal electronics
- 2 Display with infra-red interface on the front of the device
- 3 Position of the type label on the underside of the device
- 4 On/off switch on the right side of the device
- 5 Faston connection on the rear of the device
- 6 4 fixing holes on the rear of the device
- 7 Electrical connections for motor and sensors are led out of the control system in the form of industrial plugs on the left side

4.3 Model name and type label

4.3.1 Model name

The following control system types are available as ST-83x/ST-84x:

Type	Description
ST-830	<ul style="list-style-type: none"> ■ Vehicle control system of the 8th generation ■ Triac control system with 3-phase mains infeed ■ Power class 0 for rated motor power up to 0.75 kW
ST-832	<ul style="list-style-type: none"> ■ Vehicle control system of the 8th generation ■ Triac control system with 3-phase mains infeed ■ Power class 2 for rated motor power up to 2.0 kW
ST-842	<ul style="list-style-type: none"> ■ Vehicle control system of the 8th generation ■ Triac control system with 3-phase infeed from external frequency converter ■ Separate, external power supply for internal switching power supply unit and brake (two additional busbars required) ■ Power class 2 for rated motor power up to 2.0 kW

4.3.2 Type label

The following image shows an example of a type label of an ST-830 control system.

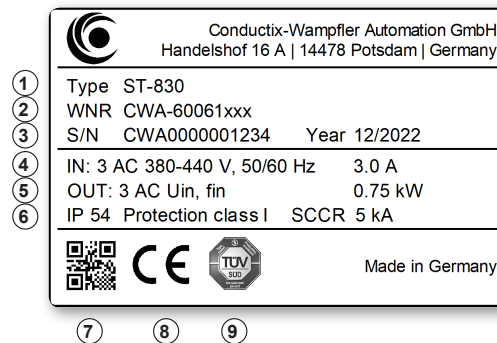

Fig. 2: ST-830 type label

- 1 Model name
- 2 Item number (WNR)
- 3 Serial number, year of construction
- 4 Rated input voltage, rated input frequency, rated input current
- 5 Output voltage, output frequency, rated motor power
- 6 Protection type, protection class, short-circuit current
- 7 QR-Code (serial number)
- 8 CE marking
- 9 TÜV Süd test mark

5 Transport and storage

5.1 Transport



NOTICE!

Transport

Incorrect or improper transport may cause damage to the device.

- Only trained personnel are allowed to transport the device.
- If necessary, use suitable transport aids.
- Transport the devices with utmost care.
- Observe the symbols on the packaging.
- Do not remove packaging and transport securing devices until you are ready to start with the installation.

5.2 Transport inspection

Check the delivery for completeness and transport damage upon receipt.

Proceed as follows in case of any apparent damage:

- Refuse to accept the delivery or accept it only conditionally. Take note of the extent of the damage and write it down on the carrier's transport documents or delivery note.
- Initiate a complaints process and report the incident to the supplier. If Conductix-Wampfler Automation is your direct supplier you will find our contact information in this document.
↳ *Chapter 'Customer service and addresses' on page 107*



Claims for damages

Claim any defect as soon as it becomes apparent. Damages can only be claimed within the applicable claim periods.

5.3 Storage



NOTICE!

Storage

Incorrect or improper storage may cause damage to the device.

- Cover connections with protective caps during storage.
- Avoid mechanical stress and vibrations.
- Store in a dry and dust-free location.
- Regularly check the condition of the stored device.
- Keep environmental conditions as specified in the technical information.
- Keep the storage temperature as specified in the technical information.



NOTICE!

Storing control systems without supply voltage

Connect devices to power supply for 5 minutes after max. 2 years of standstill.

6 Mechanical installation

Objective	This section provides details on the mechanical installation. Electrical installation is possible following successful mechanical installation.
Responsible party	<p>The system integrator (e.g. system builder, operator) is responsible for trouble-free and safe installation. As the contact person, he responds to all the fitter's queries regarding safe-to-use equipment; e.g.:</p> <ul style="list-style-type: none">■ Fire protection■ Electrical equipment■ Ladders and scaffolding■ Requirements for assembly tools■ Lifting and transportation
Required personnel	<p>Due to their training and experience, only qualified and appropriately instructed personnel are able to correctly assess the respective initial situation, identify risks and avoid hazards.</p> <p>Personnel required for installation:</p> <ul style="list-style-type: none">■ Adequately qualified fitter
Required personal protective equipment	<p>The person responsible must ensure that the personnel under his responsibility are wearing the required personal protective equipment. The required personal protective equipment satisfies the requirements for the work to be carried out and all the requirements demanded by the scope of work.</p> <p>Personal protective equipment that fulfils its intended purpose:</p> <ul style="list-style-type: none">■ protects its wearer from injury;■ reduces the seriousness and severity of potential injuries. <p>Wear:</p> <ul style="list-style-type: none">■ Work protection clothing■ Safety shoes■ Protective gloves■ Protective goggles
Safety in the work area	<ul style="list-style-type: none">■ Note the safety signs in the area around the system.■ Pay attention to the safety notes in additional applicable documentation (supplier documents).

**Work safety**

Pay attention to company and task-specific work safety regulations, as well as the country-specific legal and safety regulations applicable at the location of use.

**Wear additional protective equipment**

As an employee, you wear protective equipment supplied by the area supervisor. If work tasks have been delegated only temporarily, then you also wear any protective equipment that has become additionally required.

Special hazards**⚠ WARNING!****Live parts**

Contact with live parts poses an immediate danger to life.

- Disconnect the system from the power supply before installing the mechanical and electrical parts of the control system.

**⚠ WARNING!****Danger of falling**

Danger of falling if the control system is mounted on typical assembly sites of a monorail.

- Provide safe ascent for all activities on the control system.
- Always use certified climbing aids.

**⚠ WARNING!****Falling loads**

Risk of fatality due to falling objects

- Do not stand under loads.
- Seal off areas of mechanical installation.
- Seal off danger areas.

6.1 Open spaces and cooling

Clearance

83x / 84x-type control systems reach an operating temperature of up to 70°C in load operations. To ensure air circulation for cooling the control system, make sure there is sufficient clearance around the control system.

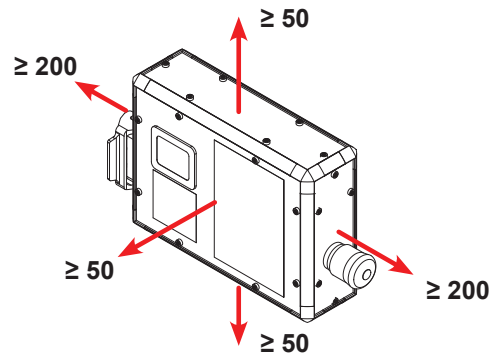

Fig. 3: Clearances around the control system (mm)



Clearance

Maintaining this clearance also provides the required space for installation and for operating the on/off switch.

Cooling

When installing the control systems one must ensure unobstructed heat dissipation through the device's rear side. Adequate convection is to be ensured through a large-surface-area connection on a heat-dissipating bearing or by means of adequate air circulation.



Preventing heat sources

Prevent sources of heat in the immediate vicinity of the control system.



Detailed device drawing

↪ Chapter 'Device drawing' on page 105

6.2 Installation location and position



NOTICE!

Collisions

Damage to system components

- Choose the position of the control system so that collisions with system components are excluded.

Installation location

The vehicle control system is intended for direct installation on the material-handling vehicle.

Observe the following points for the installation location:

- Respect the clearances to allow cooling.
- Install the control system in such way that connections and switches are accessible at all times.
- Do not cover the display with the infra-red interface.
- Note the angle of incidence of the infra-red receiver.

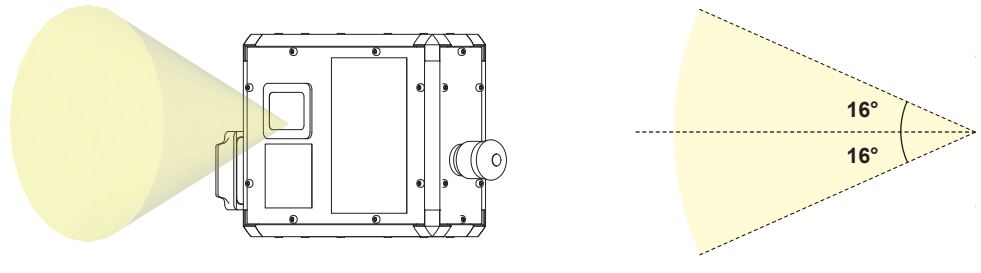

Fig. 4: Angle of incidence of the infra-red receiver (optical field of vision)

Installation position

Prescribed installation position for the control system:

- vertical
- Type label below

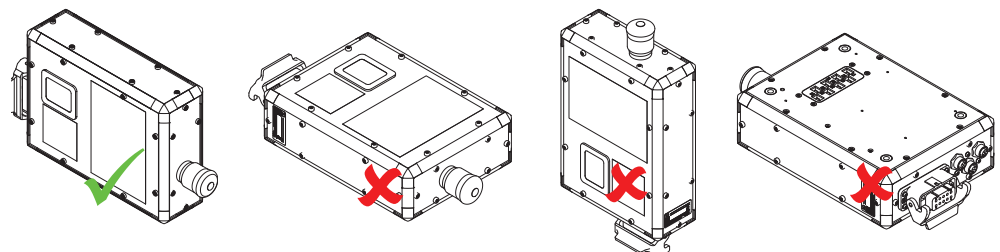

Fig. 5: Installation position

6.3 Installation



NOTICE!

Dampen impacts and vibrations

If the device is subjected to impermissible heavy impacts or vibrations, the amplitude and acceleration must be attenuated by means of appropriate measures.

- Use vibration-damping and vibration-eliminating systems.

Installation

Install the control system as follows:

Use exclusively the fixing holes of the control system for fixing the control system to the material-handling vehicle!

1. ► Assemble suitable brackets on the material-handling vehicle for assembling the control system.
2. ► Fix the control system to the brackets on material-handling vehicle by means of secure, non-loosening screw connections.

Fixing points

The control system has four fixing holes on the rear of the device.

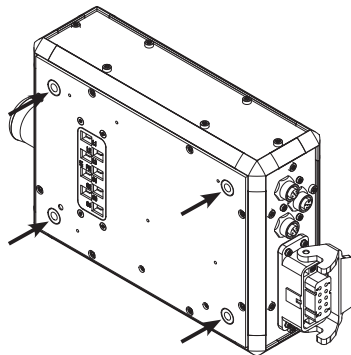

Fig. 6: Fixing holes

Number of fixing holes	4
Thread	M6
Max. screw depth	15 mm
Tightening torque	6 Nm

Dimensional drawing – fixing

Fig. 7: Dimensional drawing – fixing

**Alternative attachment points**

If the attachment points do not match those of the carrier unit, then other adapters are available for fixing upon request.

**Detailed device drawing**

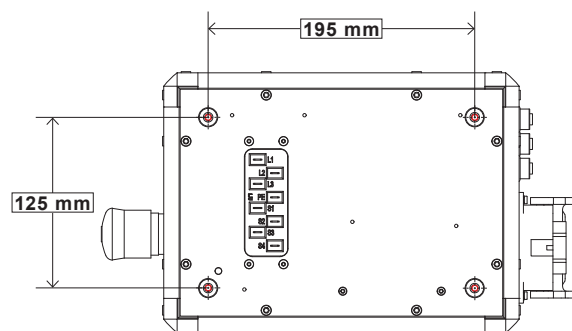
↪ Chapter 'Device drawing' on page 105

7 Electrical installation

Objective	This section provides details on the electrical installation. Commissioning is possible following successful electrical installation.
Responsible party	<p>The system integrator (e.g. system builder, operator) is responsible for trouble-free and safe electrical installation. As the contact person, he responds to all the fitter's queries regarding safe-to-use equipment; e.g.:</p> <ul style="list-style-type: none">■ Fire protection■ Electrical equipment■ Ladders and scaffolding■ Requirements for assembly tools
Required personnel	<p>Due to their training and experience, only qualified and appropriately instructed personnel are able to correctly assess the respective initial situation, identify risks and avoid hazards.</p> <p>Personnel required for electrical installation:</p> <ul style="list-style-type: none">■ Qualified electrician■ Adequately qualified fitter under the direction and supervision of a qualified electrician
Required personal protective equipment	<p>The person responsible must ensure that the personnel under his responsibility are wearing the required personal protective equipment. The required personal protective equipment satisfies the requirements for the work to be carried out and all the requirements demanded by the scope of work.</p> <p>Personal protective equipment that fulfils its intended purpose:</p> <ul style="list-style-type: none">■ protects its wearer from injury;■ reduces the seriousness and severity of potential injuries. <p>Wear:</p> <ul style="list-style-type: none">■ Work protection clothing■ Safety shoes■ Protective gloves■ Protective goggles
Safety in the work area	<ul style="list-style-type: none">■ Note the safety signs in the area around the system.■ Pay attention to the safety notes in additional applicable documentation (supplier documents).

**Work safety**

Pay attention to company and task-specific work safety regulations, as well as the country-specific legal and safety regulations applicable at the location of use.

**Wear additional protective equipment**

As an employee, you wear protective equipment supplied by the area supervisor. If work tasks have been delegated only temporarily, then you also wear any protective equipment that has become additionally required.

Special hazards**⚠ WARNING!****Live parts**

Contact with live parts poses an immediate danger to life.

- Disconnect the system from the power supply before installing the mechanical and electrical parts of the control system.

**⚠ WARNING!****Electric shock due to faulty PE connection or potential equalisation**

Risk of fatality posed by electric shock!

The vehicle control system must be earthed.

- Connect the PE connection on the rear side of the device to the system PE in accordance with EN 60204-1.

**⚠ WARNING!****Danger of falling**

Danger of falling if the control system is mounted on typical assembly sites of a monorail.

- Provide safe ascent for all activities on the control system.
- Always use certified climbing aids.

7.1 Notes about electrical installation

7.1.1 Residual current circuit breaker and mains fusing



Residual current circuit breakers react very quickly, which may lead to the control system stopping frequently. Conductix-Wampfler Automation GmbH recommends not using them.



⚠ WARNING!

**Electric shock due to incorrect residual current circuit breaker
The control system may cause direct current in the protective conductor.**

Risk of fatality posed by electric shock!

- Install fuses at the start of the mains cabling.
- Install fuses behind the busbar junction.

Residual current circuit breaker (RCCD)

If the use of a residual current circuit breaker (RCCD) is prescribed for contact protection, only these types may be used on the power supply side:

- Residual current circuit breaker (RCCD) type B
- Residual current circuit breaker (sensitive to universal current)

Mains-related fuse protection

The system must be fused on the mains side for safe operation. For mains-related fuse protection, only use the following types of fuses:

- **Fuse links for cable and line protection**
 - Operating categories: gL, gG
 - Rated mains voltage \leq rated fuse voltage
 - Configure the rated fuse current to 100% of the current according to the load.
- **Circuit breakers**
 - Type C
 - Rated mains voltage \leq rated circuit breaker voltage
 - Rated circuit breaker voltage is at least 10 % above rated motor current
 - Fuse protection of a rail section is max. 32 A

7.1.2 Electromagnetic compatibility



Triac control systems switch the 3-phase mains voltage on or off only at zero-crossings. This causes just minor interferences.

In contrast to control systems with frequency converters, no special EMC-related measures are required in the motor circuit.

EMC requirements

The standards DIN EN IEC 61000-6-2 (Generic standards – Immunity standard for industrial environments) and DIN EN IEC 61000-6-4 (Generic standards – Emission standard for industrial environments) apply for compliance with the EMC Directive 2014/30/EU.

The control systems are intended for use with industrial networks. Use in a residential environment may require additional interference-suppression measures against high-frequency interference.

Cables and connections

Only connect external components with digital interfaces (position readers, distance meters, etc.) to the control system via shielded cables.

Avoid close parallel routing of power cables with sensitive, unshielded signal cables over longer distances. Lay power cables and data cables separately.

NOTICE!



Connection with pre-assembled M12 cables

If pre-assembled shielded M12 cables are being used, the shield must be connected on both sides. The external components are usually installed so as to be insulated from the housing.

If the plug of an external component is connected conductively to the housing, it must be installed in an insulated fashion.

Earth

Earth any unused wires at both ends.

Earth the control system and the motor on the vehicle. Connect all moving parts of the vehicle to one another so as to be electrically conductive.

Make sure that all earthing and shielding connections are well-conductive and have a large surface area.

Painted parts require additional measures so that paint is removed from contact surfaces. For example, use threaded holes for screwing on, special washers (to penetrate the paint layer) or remove layers of paint.

7.1.3 Control system motor output

The control systems are only suitable for operating motors (ohmic-inductive loads).

The motor output of the control system must not be capacitively loaded. Only ohmic/inductive loads may be connected.



NOTICE!

Capacitive loads

Capacitive loads can destroy the transistors in the control system and cause the control system to fail.

- Observe the permitted motor sizes.
- Do not connect any capacitive loads.

7.1.4 Protective measures



⚠ WARNING!

Protective earthing in mobile systems

Risk of fatality posed by electric shock!

In mobile systems with direct grid feed-in, all electrical components must have a properly connected PE connection for protective grounding through the grid feed.

Overhead monorail direct grid feed

Protective earthing (PE connection) in overhead monorail applications is ensured by two consumers independent of one another on the contact line.

- Control system contact line PE connection
- Vehicle frame contact line PE connection

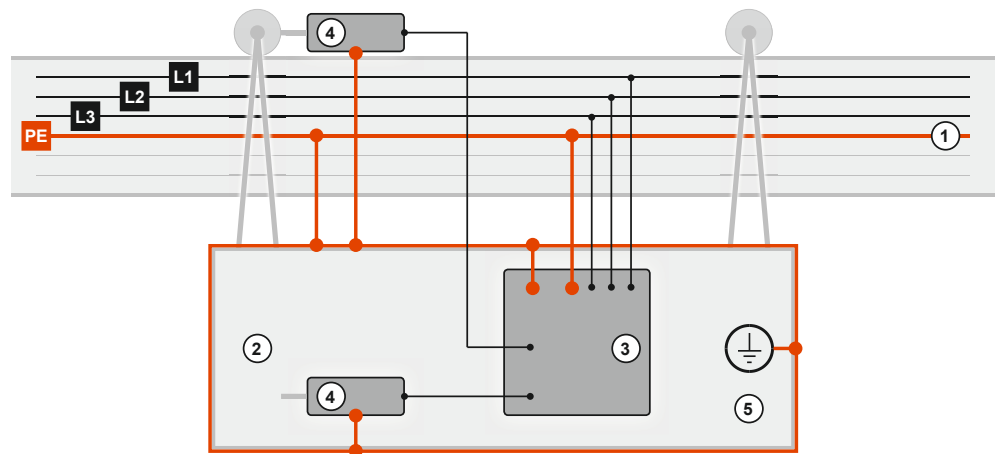

Fig. 8: Direct grid feed (diagram)

- 1 Overhead monorail rail with PE conductor
- 2 Overhead monorail vehicle
- 3 Vehicle control system
- 4 Motors
- 5 Vehicle earth

7.2 Connecting the electrical parts of the control system



NOTICE!

Malfunctions due to improper device connection

Improper device connection may lead to malfunctions during operation.

Follow the connection instructions below!

Make connections to the busbars and external components as follows:

1. ▶ Ensure that no voltage is present before connecting.
 - Switch off the vehicle control system.
 - Disconnect all busbars from the power supply and secure them against being switched on again.
2. ▶ Connect the current collectors and external components.
 - Only connect the current collectors and external components to the vehicle control system according to the [ANS] connection diagram.
 - To ensure that the protection class is achieved, only use the supplied plugs and threaded M12 plug connectors.
 - Secure plug connections against accidental loosening by means of appropriate safeguards (brackets, screw caps).
 - Do not connect cables to the vehicle control system under tension. Use strain reliefs.



Connection diagram

Observe the [ANS] connection diagram supplied with your control system.

7.3 Electrical connections
7.3.1 Connection overview

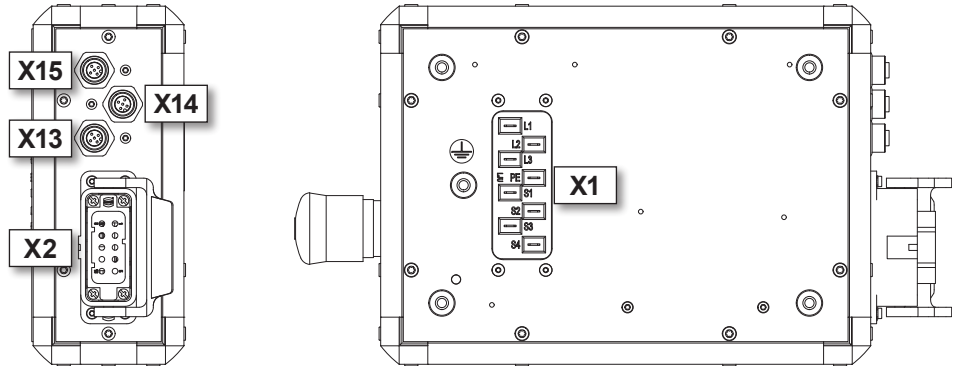

Fig. 9: ST-83x/ST-84x connections

Connection	Designation	Connect to
X1	Supply	Current collectors for power supply and command system <ul style="list-style-type: none"> ■ Control system power supply ■ Command system * <ul style="list-style-type: none"> <input type="checkbox"/> PCM system (PCM) <input type="checkbox"/> Half-wave control system (HW) <input type="checkbox"/> Z-stop system ■ Separate power supply for internal switching power supply unit (ST-84x only)
X2	Motor	Motor <ul style="list-style-type: none"> ■ Power supply ■ Brake ■ Temperature sensor
X13, X14, X15	Sensors	Sensors and actuators
⊕	PE	Vehicle PE

* project and application-dependent.
Observe the connection diagram [ANS] for your control system!

7.3.2 X1 - Supply



⚠ WARNING!

Live connections

Risk of fatality posed by electric shock!

FASTON connection

- Use secure, insulated blade receptacles.
- Use blade receptacles as per standards DIN 46 245 part 3 or DIN 46 247 part 3 or DIN 46 346 part 3.
- Use insulating housing specified by the manufacturer.
- Check firm fitting and latching function.
- Replace blade receptacles without latching function.
- Cover unused contacts.

Connection type

Function	Type	Connection image
Supply and commands	FASTON	
	6.3 mm	
	8-pin	

ST-83x - pin assignment X1 *

Pin	Signal	Description
L1	L1	Grid infeed
L2	L2	Grid infeed
L3	L3	Grid infeed
PE	PE	PE
S1	PCM, HW	PCM, HW commands
S2	M	PCM, HW messages
S3	Z1	Z-stop
S4	Z2	Z-stop

* Standard assignment. The assignment may vary depending on the project. Observe the connection diagram [ANS] for your control system!

ST-84x - pin assignment X1 *

Pin	Signal	Description
L1	L1 (FC)	Infeed from external frequency converter
L2	L2 (FC)	Infeed from external frequency converter
L3	L3 (FC)	Infeed from external frequency converter
PE	PE	PE
S1	PCM, HW	PCM, HW commands
S2	M	PCM, HW messages
S3	L2 (mains)	External power supply for internal switching power supply unit and brake
S4	L3 (mains)	External power supply for internal switching power supply unit and brake

* Standard assignment. The assignment may vary depending on the project. Observe the connection diagram [ANS] for your control system!

7.3.3 X2 - Motor

**NOTICE!****Motors with integrated brake rectifiers**

Damage to or malfunctions of the drive unit when connecting motors with integrated brake rectifier.

- Use motors without brake rectifiers.
- Remove brake rectifiers subsequently.

Connection type

Function	Type	Connection image
Motor	Harting	
	HAN10A	
	HAN10A-F use	

X2 pin assignment *

Pin	Signal	Description
1	U1	Motor winding 1
2	V1	Motor winding 1
3	W1/W2	Motor winding 1/2
4	V2	Motor winding 2
5	U2	Motor winding 2
6	BR+	Brake
7	BR-	Brake
8	<i>Unassigned</i>	
9	T1	Motor temperature sensor
10	T2	Motor temperature sensor

* Standard assignment. The assignment may vary depending on the project. Observe the connection diagram [ANS] for your control system!

7.3.4 X13, X14, X15 sensors



NOTICE!

Excessive total current of external consumers

The maximum output current at one output [OUT] may not exceed 0.25 A.

The total current at all outputs [OUT] together may not exceed 0.5 A.

Connection type

Function	Type	Connection image
Sensors	M12 socket	
	5-pin	
	A-coded	

X13 pin assignment

Pin	Signal	Description
1	L+	+ 24 V DC Supply OUT
2	IN1	+ 24 V DC Digital IN*
3	L-	GND
4	IN1	+ 24 V DC Digital IN*
5	IN1	+ 24 V DC Digital IN*

* Pin 2, 4 and 5 connected internally

X14 pin assignment

Pin	Signal	Description
1	L+	+ 24 V DC Supply OUT
2	IN2	+ 24 V DC Digital IN
3	L-	GND
4	IN3	+ 24 V DC Digital IN
5	OUT1	+ 24 V DC Digital OUT

X15 pin assignment

Pin	Signal	Description
1	L+	+ 24 V DC Supply OUT
2	IN4	+ 24 V DC Digital IN
3	L-	GND
4	IN5	+ 24 V DC Digital IN
5	OUT2	+ 24 V DC Digital OUT

7.4 Earthing the control system

The vehicle control system must be earthed for proper operation. To do this, connect the PE connection on the rear of the device to the system PE/ vehicle PE in accordance with EN 60204-1.

The PE connection is indicated by the symbol for protective earth. ⊕

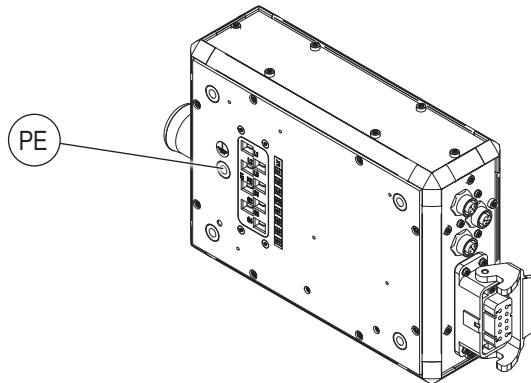

Fig. 10: ST-83x/84x PE connection

Thread	M6
Max. screw depth	15 mm
Tightening torque	6 Nm
Cable type	Earth wire or braided copper strip
Wire cross-section	≥ 2.5 mm ² (AWG 14) Like the wire cross section of L1, L2, L3 at a minimum!

8 Commissioning

Objective	This section provides details on correct commissioning. Daily operation can start following successful commissioning.
Responsible party	<p>The system integrator (e.g. system builder, operator) is responsible for trouble-free and safe commissioning. As the contact person, he responds to all the commissioner's queries regarding safe-to-use equipment; e.g.:</p> <ul style="list-style-type: none">■ Fire protection■ Electrical equipment■ Ladders and scaffolding
Required personnel	<p>Due to their training and experience, only qualified and appropriately instructed personnel are able to correctly assess the respective initial situation, identify risks and avoid hazards.</p> <p>Personnel required for commissioning:</p> <ul style="list-style-type: none">■ Staff of Conductix-Wampfler Automation GmbH■ Sufficiently trained specialist personnel
Required personal protective equipment	<p>The person responsible must ensure that the personnel under his responsibility are wearing the required personal protective equipment. The required personal protective equipment satisfies the requirements for the work to be carried out and all the requirements demanded by the scope of work.</p> <p>Personal protective equipment that fulfils its intended purpose:</p> <ul style="list-style-type: none">■ protects its wearer from injury;■ reduces the seriousness and severity of potential injuries. <p>Wear:</p> <ul style="list-style-type: none">■ Work protection clothing■ Safety shoes■ Protective gloves■ Protective goggles
Safety in the work area	<ul style="list-style-type: none">■ Note the safety signs in the area around the system.■ Pay attention to the safety notes in additional applicable documentation (supplier documents).

**Work safety**

Pay attention to company and task-specific work safety regulations, as well as the country-specific legal and safety regulations applicable at the location of use.

**Wear additional protective equipment**

As an employee, you wear protective equipment supplied by the area supervisor. If work tasks have been delegated only temporarily, then you also wear any protective equipment that has become additionally required.

Special hazards**⚠ WARNING!****Open connections**

Contact with live parts poses an immediate danger to life.

- Work on open connections only by trained personnel.
- Do not put control system into service with open connections.
- Take protective measures against accidental contact with open connections.

**⚠ WARNING!****Missing protective coverings**

Risk of fatality posed by electric shock!

- Install missing protective coverings in compliance with regulations.
- Replace damaged protective coverings.
- Do not put control system into operation without protective coverings.

**⚠ WARNING!****Ineffective emergency stop**

Danger posed by uncontrolled device behaviour when the emergency-stop function is ineffective.

- Installation and commissioning only by trained personnel.
- Commissioning only with functioning emergency-stop equipment.

**⚠ WARNING!****Incorrect device settings**

Device malfunctions due to incorrect configuration.

Death or serious injuries could result.

- Installation and commissioning only by trained personnel.
- Check device settings.

**⚠ WARNING!****Impact and crushing due to motor (suddenly) starting up.**

Risk of crushing limbs, catching and dragging of loose items of clothing due to moving machine parts.

- Ensure that there are no people in the work area of powered parts before activating the control system.
- Instructions for initial commissioning for testing the connected sensors and the input parameters / training of personnel.
- Keep clear of moving system parts.
- Do not reach into the running machine.
- Wear tight-fitting work clothes.
- Pay attention to optical and acoustic warning equipment.

**⚠ WARNING!****Danger of falling**

Danger of falling if the control system is mounted on typical assembly sites of a monorail.

- Provide safe ascent for all activities on the control system.
- Always use certified climbing aids.

**NOTICE!****Danger posed by electric arcs**

Damage to electrical components.

- Pull cable connections when they are not voltage.
- Only connect cable connections when they are de-energised.

8.1 Notes about commissioning

Requirements

Requirements for commissioning the control system:

- Correct mechanical installation
- Correct electrical installation
- System and drives fit the agreed project specifications
- Safety precautions have been taken so that no danger is posed to man or machine
- Drive units are secured against unintended start-up by means of suitable safety measures

The following are required for commissioning:

- Manual programming device MU-705 (operating manual)
- Hand-held remote control (operating manual)
- Project-specific software description for the control system (BV)
- Project-specific configuration file for the manual programming device (mtp file)

Pre-set parameter values

The vehicle control system is supplied without valid parameters. This status is indicated by the message **[PAR]** on the display of the vehicle control system (following activation).

The correct functioning of the control system is only ensured once the operating parameters based on the mechanical and electrical conditions of the system have been entered.



NOTICE!

Pre-set parameter values

Control systems are subjected to testing by Conductix-Wampfler Automation GmbH before delivery. In this process, the software is installed and test parameters are set.

The pre-set parameter values are **not customer-specific** and may differ considerably from system-specific parameter values.

NOTICE!**Pre-set parameter values in the MU-705 manual programming device**

All parameters on the delivered MU-705 manual programming device are pre-set with valid values, although not necessarily ones that conform to the system requirements.

- Every parameter value must be checked!

8.2 Commissioning procedure

1. **Switch on control system**
↳ Chapter 'Switch on control system' on page 56
 2. **Assign control system parameters**
↳ Chapter 'Assign control system parameters' on page 57
 3. **Test control system**
↳ Chapter 'Test control system' on page 63
 4. **Optimise settings**
↳ Chapter 'Optimise settings' on page 69
- ⇒ **Control system is ready for operation.**

8.3 Switch on control system

Switch on the control system as follows:

- ➔ Unlock the on/off switch of the control system by turning it clockwise and pull the switch out until a green ring appears on the switch.

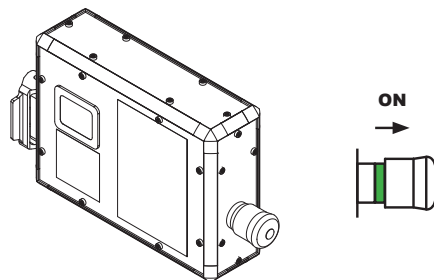

- ⇒ The control system starts. When the start-up process is complete, the message **[PAr]** flashes in the control system display.

8.4 Assign control system parameters



Transfer of risk

The transfer of risk occurs when the operating parameters are entered and the operating parameters are transferred to the vehicle control system.

This chapter describes the basic procedure for assigning parameters to a vehicle control system.

Defined data records are edited by means of the MU-705 manual programming device or the MU-705 Utility software, and then transferred to the vehicle control system using the MU-705 manual programming device. Once the transfer is completed successfully, the vehicle control system has parameters assigned.

These data records consist of:

- Parameters and configuration switches
- Vehicle tables

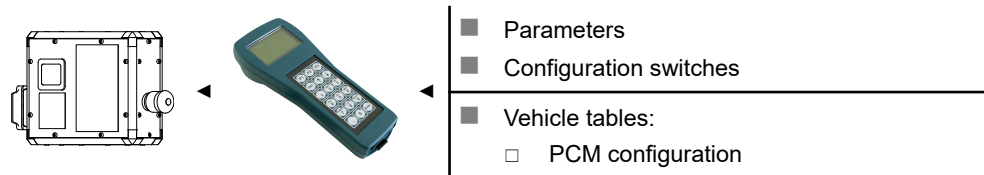

Reference

For information about the manual programming device, please refer to the corresponding operating manual:

- *BDA_0005_MU-705.pdf*

The operating manual is part of the project documentation or can be downloaded from www.conductix.com.



Reference

For information about the MU-705 utility software, please refer to the corresponding description:

- *SWB_0015_MU-705 Utility v2.x.pdf*

The description is part of the project documentation or can be downloaded from www.conductix.com.

8.4.1 Vehicle parameters and configuration switches

The data records for vehicle parameter assignment, in which values are defined for particular vehicle functions, consist of vehicle parameters and configuration switches.

The vehicle behaviour is specified using vehicle parameters and the configuration switches. Furthermore, different control system functions can be activated, deactivated and modified. The parameters are set according to the system requirements.



Reference

Information on the vehicle parameters and configuration switches used can be found in the project-specific software description BV, included in the scope of delivery!

Parameter values

Positive values from 0 to a maximum 65535 can be set as parameter values. The value range is limited further for some parameters.



Parameter values

Parameter values are held by the MU-705 manual programming device at reasonable limits.

It is not possible to set a value beyond this defined range with the MU-705 manual programming device. If parameters have to be transferred to the control system in a way other than using the MU-705 manual programming device, you have to note the specified value range. If a parameter value is outside the specified limits, this may lead to a vehicle control system malfunction or to an error message.

Configuration switch

Configuration switches are a part of the vehicle parameters. They activate or deactivate individual control system functions.

Each configuration switch can only assume one of two states:

- on
- off



8.4.1.1 Creating and saving parameters and configuration switches

Parameters and configuration switches are edited and saved in the MU-705 manual programming device and in the MU-705 utility software.

The parameters are organised for processing according to the logical sequence of the parameter assignment steps.

If a MU-705 manual programming device is delivered for control purposes, all the parameters and configuration switches specific to the control system are pre-set with valid values, but not necessarily those that conform to the system requirements. The *[PAR]* parameter (release key) is one exception.

Editing and saving parameters and configuration switches with the MU-705 manual programming device:

1.  Open menu item "Parameters" → "Modify data".
2.  Edit parameters or configuration switches.
3.  Press ESC to exit menu item.
 - ⇒ Modifications to the parameters and configuration switches are stored in the MU-705 manual programming device.



Creating individual parameters

If only individual parameters of a pre-configured vehicle control system have to be adjusted as part of system optimisation, it is recommended to read and archive the parameters and settings for the configuration switches from the vehicle control system prior to modification. This ensures that the values in the MU-705 manual programming device match those in the vehicle control system.



NOTICE!

Regular data backups

Property damage may result from data losses.

- Regularly perform backups of your data onto a separate computer.
- For backups on a PC, it is recommended to use the MU-705 Utility program.

8.4.1.2 Transferring parameters and configuration switches

Parameters and settings of the configuration switch are transferred to the vehicle control system using the MU-705 manual programming device.

Transferring parameters and configuration switches with the MU-705 manual programming device:

1. ▶ Open menu item "Parameters" → "Write data".
2. ▶ Press the F1 key [Yes] to confirm the 'Send' request.
3. ▶ Establish infrared communication.
 - ⇒ Parameters and settings of the configuration switch are transferred from the MU-705 manual programming device to the vehicle control system.



Parameters and configuration switches

The parameters and settings of the configuration switches are always transferred together!

8.4.2 Vehicle tables

Vehicle tables contain data used by certain control system functions. This data is assigned to the system in which the vehicle control system is used.

The vehicle tables are used to set values that affect the motion and positioning functions.

ST-83x/ST-84x – Vehicle tables:

- PCM configuration tables



Reference

Information on the tables used can be found in the project-specific software description BV, included in the scope of delivery!

Configuration table

In the PCM command system, different half-cycle patterns are transferred to the vehicle control system via the PCM hardware. The vehicle control system is able to recognise these commands and adjust its behaviour accordingly. The PCM configuration table defines how the vehicle control system behaves with a PCM command.



NOTICE!

Table values as per checked system documentation

For fault-free operation of the vehicles, the table values must be checked using the system documentation.

8.4.2.1 Creating and saving vehicle tables

Vehicle tables are edited and saved in the MU-705 manual programming device and in the MU-705 utility software.

Editing and saving tables with the MU-705 manual programming device:

1. ▶ Open menu item "Tables" → "...table" → "Modify tab."
2. ▶ Edit table.
3. ▶ Press ESC to exit menu item.

⇒ Modifications to the table are stored in the MU-705 manual programming device



Editing individual table entries

If only individual table entries of a pre-configured vehicle control system have to be adjusted as part of system optimisation, it is recommended to read and archive the tables from the vehicle control system prior to modification. This ensures that the values in the MU-705 manual programming device match those in the vehicle control system.



NOTICE!

Regular data backups

Property damage may result from data losses.

- Regularly perform backups of your data onto a separate computer.
- For backups on a PC, it is recommended to use the MU-705 Utility program.

8.4.2.2 Transferring vehicle tables

Vehicle tables are transferred to the vehicle control system using the MU-705 manual programming device.



Vehicle tables

Vehicle tables can be transferred individually or all together!

Transferring an individual table with the MU-705 manual programming device:

1. ▶ Open menu item "Tables" → "...table" → "Write tab."
2. ▶ Press the F1 key [Yes] to confirm the 'Send' request.
3. ▶ Establish infrared communication.
 - ⇒ The selected table is transferred from the MU-705 manual programming device to the vehicle control system.

Transferring all tables with the MU-705 manual programming device:

1. ▶ Open menu item "Tables" → "All tables" → "Write".
2. ▶ Press the F1 key [Yes] to confirm the 'Send' request.
3. ▶ Establish infrared communication.
 - ⇒ All tables are transferred from the MU-705 manual programming device to the vehicle control system.

8.5 Test control system

The following parameters can be tested after parameter assignment:

- ↪ Chapter 'Test – motor functions' on page 64
- ↪ Chapter 'Test – Sensors and peripherals' on page 66
- ↪ Chapter 'Test – Communication' on page 67



⚠ WARNING!

Unchecked parameter values

Unchecked parameter values can lead to uncontrolled drive movements.

- Decouple gear system before first test.



⚠ WARNING!

Non-standard key assignment on the hand-held remote control

The drive can perform undesired movements if a different key is assigned on the hand-held remote control.

- Observe the remote control commands in the project-specific software description BV, included in the scope of delivery!



To be observed at all times!

This chapter deals with the key assignment of the hand-held remote control as well as the names used for display modes, error codes, parameters, etc. These are standard assignments/names.

The key assignment of the hand held remote control as well as the names for display modes, error codes, parameters, etc. may vary according to the project.

Required for the control system test:

- *Project-specific software description BV, included in the scope of delivery*

8.5.1 Test – motor functions

When testing the motor functions, the mechanical and electrical functions of the connected drive motor are checked.





We recommend using a remote control to give brief commands to the control system.

Motor rotation test

During the test make sure that:

- the motor is rotating in the correct direction.
- the motor rotates at the correct speed.



Test the motor as follows:

1. ▶ Point the hand-held remote control at the display of the control system.
2. ▶ Press the asterisk  key on the hand-held remote control to put the control system into manual mode.
 - ⇒ The control system is in manual mode.
 - The '*manual mode*' is indicated by an '*H*' flashing in the display of the control system.
3. ▶ Press the right  direction key on the hand-held remote control.
 - ⇒ The mechanical brake (if present) is released and the motor rotates slowly.
4. ▶ Press the asterisk  key and right  direction key simultaneously on the hand-held remote control.
 - ⇒ The mechanical brake (if present) is released and the motor rotates fast.

Brake test

If the motor used has a mechanical brake, it can be released regardless of the rotation of the motor shaft. To test the brake, a "Release brake" command is transmitted to the control system using the remote control.

Test the brake as follows:

1. ▶ Point the hand-held remote control at the display of the control system.
2. ▶ Press the asterisk  key on the hand-held remote control to put the control system into manual mode.
 - ⇒ The control system is in manual mode.
 - The '*manual mode*' is indicated by an '*H*' flashing in the display of the control system.
3. ▶ Press the asterisk  key and up  direction key simultaneously on the hand-held remote control.
 - ⇒ The brake is released. You can hear an audible click.

Motor temperature sensor test

If the connected motor is equipped with a temperature sensor, you can test whether it is working or not. You can check whether the control system is reading a valid temperature value in the motor temperature display mode.

Test the motor temperature sensor as follows:

1. ▶ Set the **Display mode 14** (Motor temperature) on the control system.
 - In the manual programming device MU-705, open the menu item *'Tag/Number → Display'*.
 - Enter *'14'*.
 - Transfer the change to the control system.
2. ▶ Check the value indicated in the control system display.

Display	Meaning
0	The control system can read out a valid value <ul style="list-style-type: none"> ■ Temperature sensor OK
1	The control system cannot read out a valid value. <ul style="list-style-type: none"> ■ Temperature sensor not OK Possible causes: <ul style="list-style-type: none"> <input type="checkbox"/> Faulty temperature sensor. <input type="checkbox"/> Wiring fault. <input type="checkbox"/> No temperature sensor is connected.

8.5.2 Test – Sensors and peripherals

Test for digital inputs

The switching states of the connected components can be displayed and checked via the display mode for the I/O card inputs. Each activated input of the I/O card sets a defined bit in the display value.

Test the digital inputs as follows:

1. ➤ Set the **Display mode 40** (I/O card inputs) on the control system.
 - In the manual programming device MU-705, open the menu item 'Tag/Number → Display' .
 - Enter '40' .
 - Transfer the change to the control system.
2. ➤ Set or erase input bits and check the values shown in the control system display.



Reference

For information about the individual bits, please refer to the supplied project-specific BV software description.

Test for digital outputs

The display mode for I/O card outputs can be used to check the switching states of the I/O card outputs. Outputs are set in a test-like manner using the parameter "Test Outputs". [CTsO]



To activate and deactivate outputs for testing purposes, the control system must be in unrestrained manual mode.

Test the digital outputs as follows:

1. ➤ Set the **Display mode 41** (I/O card outputs) on the control system.
 - In the manual programming device MU-705, open the menu item 'Tag/Number → Display' .
 - Enter '41' .
 - Transfer the change to the control system.
2. ➤ For the output test, set the corresponding bit in the "Test Outputs" parameter [CTsO] and check the value shown in the control system display and the switching status at the corresponding output component.



Reference

For information about the individual bits, please refer to the supplied project-specific BV software description.

8.5.3 Test – Communication

Test for PCM commands

Requirement for the automatic operation of the vehicle is the detection and processing of commands on the command rail. The display mode for the PCM commands can be used to check whether the control system is receiving them correctly.

Check the recognition of the PCM commands as follows:

1. ➤ Set the **Display mode 50** (PCM command) on the control system.
 - In the manual programming device MU-705, open the menu item 'Tag/Number → Display'.
 - Enter '50'.
 - Transfer the change to the control system.
2. ➤ Check the PCM command received. This is shown as a decimal value in the control system display.



Reference

For information about the PCM commands, please refer to the supplied project-specific BV software description.

Z-stop test

If Z-stop is used as a command system, the signal detection on the control system can be tested. A Z-stop signal is placed on the relevant rail by a vehicle in the successor segment. The signal input can be checked in the display mode for the Z-stop.



Check the signal recognition as follows:

1. ➤ Make sure that there is a vehicle in the successor segment.
2. ➤ Set the **Display mode 53** (Z-stop) on the control system.
 - In the manual programming device MU-705, open the menu item 'Tag/Number → Display'.
 - Enter '53'.
 - Transfer the change to the control system.
3. ➤ Check the incoming signal.
 - ⇒ The Z-stop signal is a solid wave. The display of the control system must indicate '202'.

Test messages

The transmission of messages to the signal rail is important as feedback for the system controller. Pending messages can be displayed via the messages display mode on the control system and checked on the system PLC or through the LED states on the PCM input module.

Test the messages as follows:

1.  Set the **Display mode 55** (Messages) on the control system.
 - In the manual programming device MU-705, open the menu item 'Tag/Number → Display' .
 - Enter '55' .
 - Transfer the change to the control system.
2.  Depending on the configuration, establish the corresponding control system status (error, manual mode, positioned, etc.).
3.  Check the output message in the control system display, in the system PLC and on the PCM input module.



Reference

For information about the messages, please refer to the supplied project-specific BV software description.

8.6 Optimise settings

Regenerative braking

In order to slow down a vehicle, to stop in a targeted manner and to protect the brake, the control system offers the option of regenerative braking (also known as pulse braking).

With regenerative braking, it is possible to slowly decelerate the vehicle via the torque of the motor, similar to an inverter braking ramp.

For this purpose, when switching from the two-pole winding to the slower (usually 8-pole) winding of the pole-changing motor, the regenerative characteristic curve of the 8-pole motor winding is influenced by pulsing the phases in such a way that a regenerative braking behaviour is achieved up to the operating point of the 8-pole winding, and only from then on does the remaining braking take place via the mechanical brake.

The braking behaviour is configurable.

The setting is made via the parameters:

- *[CTri]* for setting the braking behavior - soft, hard
- *[TPO]*, *[TCO]* for setting the times for opening and closing the mechanical brake
- *[TP2P]*, *[T13P]* for phase switching
- *[TBL]*, *[TBS]*, *[TBS2]* for braking time adjustment
- *[BP]* for braking pulse adjustment



Reference

For a detailed description of regenerative braking and further information about the parameters, please refer to the supplied, project-specific BV software description.

PCM time delays

If an old control system is to be replaced with an ST-83x/ST-84x, the control systems may react at different speeds to input signals from PCM commands. To compensate for this time offset, it is possible to set delay times for the commands with the parameters 'PCM delay time' *[TPc0]* and *[TPc]*.



Reference

For information about the parameters, please refer to the supplied project-specific BV software description.

9 Operation

Objective	This section explains the work steps required by the operator.
In daily operation	<p>In daily operation the system is used in automated fashion, so that:</p> <ul style="list-style-type: none"> ■ The safety of personnel is ensured. ■ Workflows and functions are monitored using control system technology. ■ Trained users are supported in ongoing processes at regular intervals.
Responsible party	<p>The operator, or supervisory personnel appointed by him, is responsible for a safe and seamless workflow. As the contact person, he responds to all the personnel's queries regarding safe-to-use equipment; e.g.:</p> <ul style="list-style-type: none"> ■ Fire protection ■ Electrical equipment
Required personnel	<p>Due to their training and experience, only qualified and appropriately instructed personnel are able to correctly assess the respective initial situation, identify risks and avoid hazards.</p> <p>Personnel required for everyday operation:</p> <ul style="list-style-type: none"> ■ Qualified and appropriately instructed operating personnel ■ Qualified and appropriately instructed maintenance personnel
Required personal protective equipment	<p>The person responsible must ensure that the personnel under his responsibility are wearing the required personal protective equipment. The required personal protective equipment satisfies the requirements for the work to be carried out and all the requirements demanded by the scope of work.</p> <p>Personal protective equipment that fulfils its intended purpose:</p> <ul style="list-style-type: none"> ■ protects its wearer from injury; ■ reduces the seriousness and severity of potential injuries. <p>Wear:</p> <ul style="list-style-type: none"> ■ Work protection clothing ■ Safety shoes ■ Protective gloves ■ Protective goggles
Safety in the work area	<ul style="list-style-type: none"> ■ Only work when protection and monitoring equipment are active. ■ Pay attention to the safety signs at the work station and its immediate vicinity. ■ Only load load-bearing machinery within the permitted limits. ■ Secure goods to be transported against loss.



Work safety

Pay attention to company and task-specific work safety regulations, as well as the country-specific legal and safety regulations applicable at the location of use.



Wear additional protective equipment

As an employee, you wear protective equipment supplied by the area supervisor. If work tasks have been delegated only temporarily, then you also wear any protective equipment that has become additionally required.

Special hazards



⚠ WARNING!

Automatic start-up

Danger posed by unintended activation of the control system and start-up of motors and drive units.

Risk of crushing limbs, catching and dragging of loose items of clothing due to moving machine parts

- No persons in the danger zone of moving system parts
- Deactivate automatic start-up
- Only activate control system under supervision
- If necessary, disengage the drive.
- If necessary, disconnect the vehicle from voltage.
- Keep clear of moving system parts.
- Do not reach into the running machine.
- Wear tight-fitting work clothes.
- Pay attention to optical and acoustic warning equipment.



⚠ WARNING!

Hazardous voltages on ports and cables

Open electrical components

- Do not pull plugs carrying voltage.
- Do not contact open cables.



⚠ WARNING!

Risk of fire due to hot surfaces

Highly flammable materials may catch fire if they come in direct or indirect contact with the hot surfaces of the device.

- Ensure that the air around the device is constantly circulated.
- Do not place any flammable materials on top of the device.
- Keep flammable materials away from the housing surface and the heat sink.



⚠ CAUTION!

Hot surfaces

Risk of burns posed by hot surfaces of the control system and connected components.

- Install protective equipment and check it regularly.
- Prior to working on the control system, allow the connected components to cool down.

9.1 Operating modes

Operating modes

The control system can be operated in the following ways:

- Automatic mode
- Manual mode
- Unrestrained manual mode

Automatic mode

In automatic mode, the control system responds to PCM and half-wave commands of the higher-level system controller, or the control system works through an internally defined driving program. In the event of errors, the control system stops.

Manual mode

The control system can be operated via the remote control in manual mode. Errors are only evaluated to a limited degree in manual mode. When switching to manual mode or back to automatic mode, any present errors are reset. If the cause of the problem continues to exist, however, then the relevant message appears on the display.

Unrestrained manual mode

In unrestrained manual mode, it is possible to operate the control system despite errors being present. The control system responds exclusively to communication errors. Software restrictions set through the parameters are overridden in this operating mode. Hardware-induced restrictions remain in place.

9.2 Switching the control system on and off

9.2.1 Switch on control system

Switch on the control system as follows:

- ➔ Unlock the on/off switch of the control system by turning it clockwise and pull the switch out until a green ring appears on the switch.

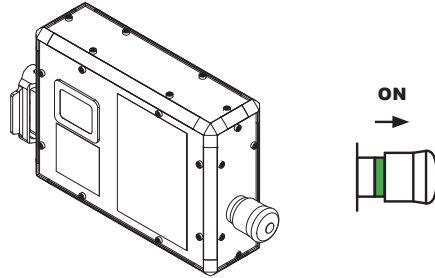

- ⇒ The control system starts. Once the start-up process is complete, the control system display shows the current status of the control system.



- *The control system starts in the operating mode that was active before the control system was switched off.*
- *The display starts in the last display mode set.*

9.2.2 Switches the control system off

Switch off the control system as follows:

- ➔ Press the on/off switch of the control system towards the control system until the switch engages and the green ring on the switch disappears.

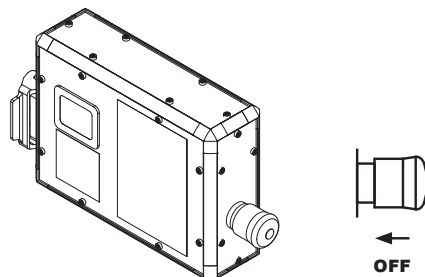

- ⇒ The control system is switched off.

9.3 Display with infra-red interface

A display with an infra-red interface is built into the front of the device. It provides the operator with information about the status of the control system and allows the control system to be remotely operated, parametrised and programmed.



- 1 Display with infra-red interface consisting of:
- 2 four-digit, 7-segment display
- 3 Infra-red interface

When using the infra-red interface,

- make sure that the transmitter/receiver of your IR input device is within the communication range of the control system.
- make sure that the ranges of the input devices are observed.

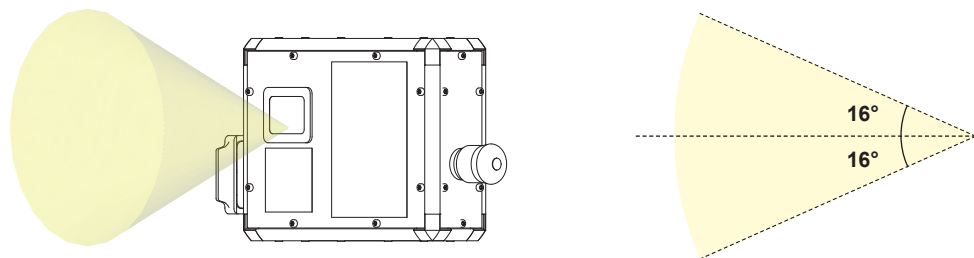



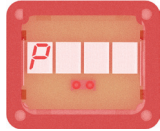

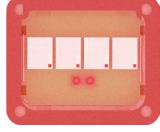

Fig. 11: ST-83x/ST-84x - angle of incidence

Input device	Minimum range	Typical range
Remote control	6 m	10 m
Manual programming device	0.5 m	1 m

9.4 Displays
9.4.1 Operation displays

Display	Description												
	<p>Vehicle in automatic mode when no errors are present</p> <p>By default, the display is set to display mode 0 'Vehicle status' ¹ indicating the current operating status.</p> <table border="1"> <tr><td>1</td><td>Slow movement</td></tr> <tr><td>2</td><td>Fast movement</td></tr> <tr><td>8</td><td>Brake is being released</td></tr> <tr><td>-</td><td>Stop (no driving command)</td></tr> <tr><td>-</td><td>Stop push-button actuated</td></tr> <tr><td>-</td><td>Z-stop or approach sensor</td></tr> </table>	1	Slow movement	2	Fast movement	8	Brake is being released	-	Stop (no driving command)	-	Stop push-button actuated	-	Z-stop or approach sensor
1	Slow movement												
2	Fast movement												
8	Brake is being released												
-	Stop (no driving command)												
-	Stop push-button actuated												
-	Z-stop or approach sensor												
	<p>Vehicle in manual mode</p> <p>If the vehicle is in manual mode, an 'H' flashes in the display of the control system.</p>												
	<p>Vehicle in unrestrained manual mode</p> <p>If the vehicle is in unrestrained manual mode, an 'HU' flashes in the display of the control system.</p>												
	<p>Vehicle in position</p> <p>If the control system has been configured to position the vehicle, a 'P' flashes in the control system display as soon as the vehicle has been properly positioned.</p>												
	<p>Error pending</p> <p>If the vehicle is in error mode, the error number with a preceding '-' flashes in the display of the control system.</p>												
	<p>Write parameters to BIOS active</p> <p>If parameters have been changed and transferred to the control system using the manual programming device, they are then automatically written to the BIOS of the control system. During the writing process, '545' flashes in the display of the control system.</p>												
	<p>Other displays (dots in the display)</p> <table border="1"> <tr><td>.</td><td>1st digit from left: Driving command present</td></tr> <tr><td>.</td><td>2nd digit from left: IR communication</td></tr> <tr><td>.</td><td>3rd digit from left: Error</td></tr> <tr><td>.</td><td>4th digit from left: Tables loaded</td></tr> </table>	.	1st digit from left: Driving command present	.	2nd digit from left: IR communication	.	3rd digit from left: Error	.	4th digit from left: Tables loaded				
.	1st digit from left: Driving command present												
.	2nd digit from left: IR communication												
.	3rd digit from left: Error												
.	4th digit from left: Tables loaded												

¹ The display mode can be changed using the manual programming device. For information on changing the display mode, please refer to [Chapter 'Display modes' on page 78](#)

9.4.2 Display modes

The display can be configured via the display mode setting. Depending on the setting, various status information is shown alphanumerically in the display.

Values are shown in **decimal** or **hexadecimal** format.

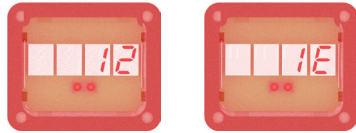

Fig. 12: Decimal/hexadecimal display

- Decimal values can be read directly.
- Hexadecimal values may have to be converted for evaluation.
 🔗 Chapter 'Calculating and evaluating hexadecimal values' on page 79

9.4.2.1 Creating/modifying display modes

The display modes are set with the manual programming device MU-705.

1. ➤ In the manual programming device MU-705, open the menu item 'Tag/Number → Display'.
2. ➤ Enter the number of the display mode to be shown.
3. ➤ Transfer the change to the control system
 ⇒ The display indicates the new status information.



Reference

For information about the display modes, please refer to the supplied project-specific BV software description.



Reference

For information about the manual programming device, please refer to the corresponding operating manual:

- *BDA_0005_MU-705.pdf*

The operating manual is part of the project documentation or can be downloaded from www.conductix.com.

9.4.2.2 Calculating and evaluating hexadecimal values

Some values are displayed in the form of a hexadecimal number. To evaluate what the displayed number means, the number must be converted into binary format.

Hexadecimal	0	1	2	3	4	5	6	7
Binary	0000	0001	0010	0011	0100	0101	0110	0111

Hexadecimal	8	9	A	B	C	D	E	F
Binary	1000	1001	1010	1011	1100	1101	1110	1111

Example:

- Display mode 40 'I/O card inputs'
- Hexadecimal display 1E

	Hex	1				E			
	Binary	0	0	0	1	1	1	1	0
	Bit	0080	0040	0020	0010	0008	0004	0002	0001

Meaning of display mode 40 'I/O card inputs'

0001	Input X13_2/4/5 not set (low)
0002	Input X14_2 is set (high)
0004	Input X14_4 is set (high)
0008	Input X15_2 is set (high)
0010	Input X15_4 is set (high)
0020	Not used
0040	Not used
0080	Not used



Meaning of set bits

For the meaning of set or unset bits, please refer to the description of the respective display mode in the supplied project-specific BV software description.

9.5 Vehicle remote control

In automatic mode, the control system receives the relevant commands for moving the vehicle from the higher-level system controller or runs an internal driving program.

In manual or unrestrained manual mode, the vehicle can be moved manually using optional hand-held remote controls (FB) or a manual programming device (MU).



Reference

Information on the hand-held remote controls can be found in the corresponding operating manual:

- *BDA_0002_FB-606.pdf*
- *BDA_0003_FB-706.pdf*
- *BDA_0018_FB-8.pdf*

The operating manuals are part of the project documentation or can be downloaded from www.conductix.com.



Reference

For information about the manual programming device, please refer to the corresponding operating manual:

- *BDA_0005_MU-705.pdf*

The operating manual is part of the project documentation or can be downloaded from www.conductix.com.

9.5.1 Changing operating mode



⚠ WARNING!

Automatic start-up

Risk of fatality due to moving machine parts!

If the control system is in automatic mode or is going to be switched to automatic mode, an automatic start-up of the system is to be expected at any time.

- No persons in the danger zone of moving system parts!
- Only activate the control system under supervision!

Activating manual mode

1. ➤ Point the hand-held remote control at the display of the control system.

2. ➤ Press the asterisk  key on the hand-held remote control to put the control system into manual mode.

⇒ The control system is in manual mode.

- *'Manual operation'* is indicated by a flashing *'H'* in the display of the control system.

Activating automatic mode

1. ➤ Point the hand-held remote control at the display of the control system.

2. ➤ Press the hash  key on the hand-held remote control to put the control system into automatic mode.

⇒ The control system is in automatic mode

Activating unrestrained manual mode

1. ➤ Activate the *[SW12]* configuration switch in the manual programming device and transfer the new configuration to the control system.

2. ➤ Point the hand-held remote control at the display of the control system.

3. ➤ Press the asterisk  key on the hand-held remote control to put the control system into unrestrained manual mode.

⇒ The control system is in unrestrained manual mode.

- *'Unrestrained manual mode'* is indicated by a flashing *'HU'* in the display of the control system.

9.5.2 Moving the vehicle manually



⚠ WARNING!

Danger of crushing

When moving vehicles in **manual mode** or **unrestrained manual mode**, safety equipment or safety functions may be deactivated.

Death or serious injuries could result.

- The moving of vehicles in **manual mode** or **unrestrained manual mode** must only be performed by instructed personnel.
- When moving vehicles in **manual mode** or **unrestrained manual mode**, there should be no people in the action area of the vehicle.
- Operate the vehicle remotely only when it is in the line of sight.



⚠ WARNING!

Non-standard key assignment on the hand-held remote control

The drive can perform undesired movements if a different key is assigned on the hand-held remote control.

- Observe the remote control commands in the project-specific software description BV, included in the scope of delivery!



Remote control with manual programming device

Due to the short range of the manual programming device, remote operation with the manual programming device should only be carried out in exceptional cases. We recommend always using a hand-held remote control for remote operation.

Ranges:







- *Hand-held remote control: at least 6 m.*
- *Manual programming device: not more than 1 m.*

Moving using the hand-held remote control

In manual mode and unrestrained manual mode, the vehicle can be controlled with a hand-held remote control.

1. ➤ Switch to manual mode or unrestrained manual mode.
2. ➤ Operate the vehicle manually using the keys on the hand-held remote control. See following table.

Standard assignment of the hand-held remote control for an ST-83x/ST-84x







Key	Function
	Switch-over to manual mode
	Switch-over to automatic mode
	Slow forwards movement
 + 	Fast forwards movement
 + 	Release brake

Moving with the manual programming device

In manual mode and unrestrained manual mode, the vehicle can be controlled using the manual programming device.

1. ➤ Switch to manual mode or unrestrained manual mode.
2. ➤ Operate the vehicle manually using the keys on the manual programming device. See following table.

Standard assignment of the manual programming device for an ST-83x/ST-84x

Key	Function
	Switch-over to manual mode
	Switch between slow manual mode and fast manual mode
	Switch-over to automatic mode
 or 	Forwards movement (slow or fast)
 + 	Release brake

10 Faults



Note

Any detected malfunction automatically leads to an immediate stop of the vehicle!

10.1 Error indicators and messages

Error displays

If the vehicle is in error mode,

- the error number with a preceding ‘-’ flashes in the control system display.
- the different numbers appear consecutively if there is more than one active error.

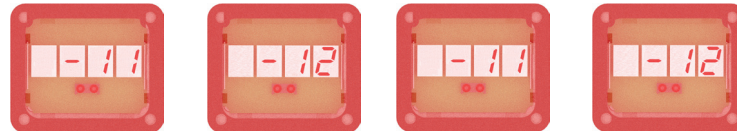

Fig. 13: Display example ‘Errors 11 and 12’



Note

The error display can be deactivated by the activated [SW13] configuration switch.



Reference

For information about the error messages, please refer to the supplied project-specific BV software description.

Messages

Faults or individual vehicle statuses can be reported by the control system to the system controller via the message rail.

The control system can generate up to three different half-wave patterns on the signal rail and make them available to the system controller for evaluation.

- Full wave
- Negative half wave
- Positive half wave

The assignment of the messages is configurable, e.g.

- Full wave = collective error message
- Negative half-wave = brake released
- Positive half-wave = presence

**Reference**

For information about the messages, please refer to the supplied project-specific BV software description.

10.2 Fault reset

Depending on the cause or effects, occurring errors reset by themselves after the cause has been eliminated or must be acknowledged manually.

- **Self-acknowledging errors**
- **Errors to be acknowledged manually**



⚠ WARNING!

Automatic start-up

Danger posed by unintended activation of the control system and start-up of motors and drive units.

Risk of crushing limbs, catching and dragging of loose items of clothing due to moving machine parts

- No persons in the danger zone of moving system parts
- Deactivate automatic start-up
- Only activate control system under supervision
- If necessary, disengage the drive.
- If necessary, disconnect the vehicle from voltage.
- Keep clear of moving system parts.
- Do not reach into the running machine.
- Wear tight-fitting work clothes.
- Pay attention to optical and acoustic warning equipment.

10.2.1 Self-acknowledging errors

Errors whose cause or effect do not lead to personal injury or damage to the system will acknowledge themselves once the cause has been eliminated.

The error message is reset automatically through a **self-reset (SR)** of the control system.

Self-acknowledging errors are saved in the error log.



NOTICE!

Monitoring the error log

Damage to the control system due to repeated errors

- Check the error logs for abnormalities to avoid permanent damage.

10.2.2 Errors to be acknowledged manually

Errors whose cause or effect could lead to personal injury, damage to the system or plant stoppages must be reset manually after the cause has been eliminated.

The error message is reset through a:

- **manual reset (MR)** or
- **power-on reset (PoR)**

Errors to be acknowledged are saved in the error log.



NOTICE!

Monitoring the error log



Damage to the control system due to repeated errors

- Check the error logs for abnormalities to avoid permanent damage.



Manual reset (MR)

Perform a manual reset by changing or confirming the operating mode.

Manual reset by changing the operating mode:

1. ▶ Point the hand-held remote control at the indicator of the control system.
2. ▶ Switch the control system to manual mode by pressing the asterisk key  on the hand-held remote control.
 - ⇒ The error will be acknowledged.
3. ▶ Switch the control system to automatic mode by pressing the hash key  on the hand-held remote control.

Manual reset by confirming the operating mode:

1. ▶ Point the hand-held remote control at the indicator of the control system.
2. ▶ Press the
 - asterisk key  on the handheld remote control in manual mode and unrestrained manual mode.
 - the hash key  on the hand-held remote control in automatic mode.
 - ⇒ The error will be acknowledged.

Power-on reset (POR)

Perform a power-on reset by switching the control system off and on again.

Power-on reset:

1. ➤ Switch the control system off from the on/off switch of the control system.
2. ➤ Switch the control system on again from the on/off switch of the control system.
 - ⇒ The error is acknowledged.

11 Service and maintenance

11.1 Maintenance and cleaning

Operation and maintenance

The operation and maintenance of the control system must only be performed by trained and qualified personnel. Staff undergoing instruction and training are allowed to perform activities on and with the control system under the constant supervision of a trained and qualified individual.



⚠ WARNING!

Danger to life from electrical current!

Contact with live parts poses an immediate danger to life.

- Disconnect the system from the power supply and secure it against being switched on again before servicing and cleaning the control system.

11.1.1 Maintenance



NOTICE!

Mechanical loads may lead to device failure.

- Check the device for damage at regular intervals.
- Opening the device for testing purposes is not intended.

Service the device as follows:

- **Brackets**
 - Check for loose connections.
- **Connections**
 - Check for loose connections.
 - Check cable insulation.
 - Cover any ports not being used.
- **Indicators**
 - Remove soiling.
- **Recommended maintenance interval**
 - 6 months

11.1.2 Cleaning



NOTICE!

Damage to the device due to improper cleaning

- Do not use any cleaning agents, such as methylated spirits, or other cleaners!
- Do not clean with sharp objects!

Clean the device as follows:

- **Device**
 - Clean with dry cloths only.
- **Recommended cleaning intervals**
 - 6 months

11.2 Removing / replacing the control system



⚠ WARNING!

Changing the control system

Danger posed by faulty installation.

Faults during installation may lead to potentially fatal situations or considerable material damage.

- Have installation performed exclusively by employees of the manufacturer or by trained personnel authorised by it.
- Works on electric components may only be carried out by qualified electricians or persons instructed and supervised by a qualified electrician in accordance with the electro-technical regulations.
- Only disconnect plug connections to external componentry when in a de-energised state.
- Before carrying out work on the control system, make sure it is de-energised and secured against accidental reactivation.
- Prior to commissioning, ensure that all safety equipment is installed and functioning properly.
- Prior to commissioning, ensure that parameter assignment on the device has been performed correctly in accordance with the electrical and mechanical conditions of the system.



⚠ WARNING!

Danger from external voltage after switching off the control system

Depending on the function and installation, it is possible that external voltages, which are not switched off by the on/off switch of the control system, are fed into the control system. Contact with live parts poses an immediate danger to life.

Disconnect the power supply safely:

- Disconnect the system from the power supply.
- Disconnect the current collectors from the busbars.

All poles of the power supply must be able to be shut down and protected against being switched on again. Installation of a main switch by the system operator or system manufacturer.

11.2.1 Control system removal



Reading parameters and tables

If possible, read and save the current parameters and tables from the control system using the MU-705 manual programming device.

1. ▶ Switch off the control system.



⚠ WARNING!

Electrical voltage after shutdown

Some components of the vehicle control systems, especially the intermediate circuit of the control system's switching power supply unit, may still carry a voltage after shut-down. Work on these components may only be carried out after the intermediate circuit has discharged!

- **Waiting time after disconnection from power:** at least 10 minutes

2. ▶ Switch off the external power supply and secure it against being switched on again.
3. ▶ Disconnect all electrical connections.
4. ▶ Disconnect the mechanical connections.

11.2.2 Control system installation

1. ▶ Check the new control system for transport damage.
2. ▶ Install the mechanical parts of the control system.
↪ *Chapter 'Mechanical installation' on page 29*
3. ▶ Connect the electrical parts of the control system.
↪ *Chapter 'Electrical installation' on page 37*
Observe the [ANS] connection diagram of the control system!
4. ▶ Put the control system into operation.
↪ *Chapter 'Commissioning' on page 51*



Reading parameters and tables

Transfer saved parameters and tables of the 'old' control system to the control system using the MU-705 manual programming device.

11.3 Repairing the control system

If a repair of the control system becomes necessary, please refer to your next service partner or go directly to Conductix-Wampfler Automation GmbH.

↪ Chapter 'Customer service and addresses' on page 107



Repairs

The repair of a defective control system must only be performed by the staff of Conductix-Wampfler or specialists trained by Conductix-Wampfler.

In the event of repairs by unauthorised persons, all warranty claims against Conductix-Wampfler Automation GmbH are invalidated.

12 Disposal

12.1 Information on disposal and environmental regulations

If no return or disposal agreements exist, the individual components are to be properly dismantled and then separated and disposed of pursuant to current regulations or taken for recycling.

The device comprises electric and electronic components. Separate and dispose of them according to applicable provisions.

Follow the hazardous materials directive, in particular the regulations on handling hazardous materials.

 Materials designated for recycling are to be disposed of as per the respective recycling procedure.

13 Technical Data

13.1 Device

Types

Type	Description
ST-830	<ul style="list-style-type: none"> ■ Triac control system with 3-phase mains infeed ■ Power class 0 for rated motor power up to 0.75 kW
ST-832	<ul style="list-style-type: none"> ■ Triac control system with 3-phase mains infeed ■ Power class 2 for rated motor power up to 2.0 kW
ST-842	<ul style="list-style-type: none"> ■ Triac control system with 3-phase infeed from external frequency converter ■ Separate, external power supply for internal switching power supply unit and brake ■ Power class 2 for rated motor power up to 2.0 kW

Material

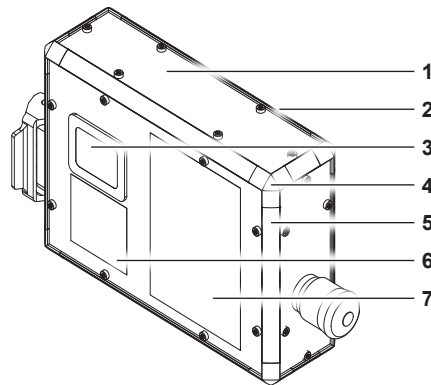

Fig. 14: ST-83x/ST-84x - material

no.	Designation	Material
1	Front and side panels	Aluminium
2	Mounting panel (rear of the device)	Aluminium
3	Display window	Plastic
4	Profile corner	ABS plastic
5	Edge profile	Aluminium with ABS plastic cover
6	Front film	Polyethylene
7	Error sticker	Polyester

Sizes and weights

	ST-830	ST-832	ST-842
Size W × H × D	260 mm × 190 mm × 81 mm		
Weight	3.0 kg		

Environmental conditions

	ST-830	ST-832	ST-842
Climatic environmental conditions as per DIN IEC 60721-3-3	Category: 3K3 (fixed-location usage*; weatherproof)		
Mechanical environmental conditions as per DIN IEC 60721-3-3	Category: 3M4 (fixed-location usage*; weatherproof)		
Vibrations as per IEC 60068-2-6	10 ... 58 Hz: ± 0.075 mm 58 ... 150 Hz: 9.81 m/s ²		
Shock as per IEC 60068-2-27	150 m/s ²		
Free fall In transport packaging	≤ 1.0 m		
Ambient temperature without derating Non-condensing, no dew-formation	+10 ... +45 °C The control system is thermally inherently safe. If the temperature is too high, the system is shut down and an error message is issued.		
Ambient temperature with derating	+45 ... +60 °C 5 %/K		
Maximum installation height without derating	1,000 m above mean sea level (AMSL)		
Relative humidity	< 80% non-condensing		
Storage temperature	-10 ... +50 °C		
Protection category	I		
Protection class	IP54 Except connection X1 (Faston on rear of device)		
EMC conformity (Interference suppression)	Complies with EN IEC 61000-6-2		

* The term **fixed-location usage** refers to use in conjunction with a rail system. The rail system must be designed so that the control system is not subjected to impermissible impacts.

13.2 Input data

Power supply

	ST-830	ST-832	ST-842
Supply type	3-phase AC connection, TT or TN mains with directly earthed star point		3-phase AC current from external frequency converter with sine filter
Rated input voltage	3 x AC 380 ... 440 V (± 10 %)		3 x AC 0... 440 V (± 10 %)
Rated input frequency	50/60 Hz (± 5 %)		<i>not specified</i>
Short-circuit current (SCCR)	5 kA	5 kA	5 kA
Power consumption Standby	max. 2 W	max. 2 W	max. 2 W
Power loss Typical, self-heating in still air by 35 K	approx. 5 W	approx. 12 W	approx. 12 W

Separate power supply for switching power supply unit

	ST-830	ST-832	ST-842
Input voltage range	<i>Not used</i>		AC 220 ... 440 V (± 10 %)
Current consumption Typical	<i>Not used</i>		max. 15 W
Input frequency	<i>Not used</i>		50 / 60 Hz (± 5 %)

Half-wave/PCM input

	ST-830	ST-832	ST-842
Input voltage range* According to hardware configuration	AC 220 ... 277 V (± 10 %) AC 380 ... 440 V (± 10 %)		
Current consumption Typical	3 mA		
Input frequency Mains-synchronous	50 / 60 Hz (± 5 %)		

* Measured against the reference phase of the inputs.

Z-stop input

	ST-830	ST-832	ST-842
Input voltage range*	AC 380 ... 440 V (± 10 %)		<i>Not used</i>
Current consumption Typical	3 mA		<i>Not used</i>
Input frequency Mains-synchronous	50 / 60 Hz (± 5 %)		<i>Not used</i>

* Measured against the reference phase of the inputs.

Digital inputs

	ST-830	ST-832	ST-842
Current consumption at 24 V	1.2 mA ± 10 %		
High level	DC +20 ... +30 V		
Low level	DC 0 ... +8 V		

13.3 Output data

Axis data

	ST-830	ST-832	ST-842
Power class	0	2	2
Rated motor power	0.75 kW	2.0 kW	2.0 kW
Rated output current	3.0 A	5.0 A	5.0 A
Maximum device currents (5s)	16 A	16 A	16 A
Operating mode as per IEC 60034-1	S9		
Output voltage	3 × AC U_{In}		
Output frequency	f_{In}		
Motor protection	PTC/bi-metal		
Maximum brake stop current	DC 0.44 A		
Brake control output voltage	DC $0.45 \times U_{In}$		DC $0.45 \times U_{In}^*$

* Depending on input voltage for separate power supply of the switching power supply unit

Signal output

	ST-830	ST-832	ST-842
Relay contact	Max. permitted voltage: 277 V Max. permissible load current: 25 mA at 85 °C (restricted by PTC)		
Integrated short-circuit protection	Yes		
Max. ohmic load	10 kΩ		

Digital outputs

	ST-830	ST-832	ST-842
Model	Short-circuit-proof		
Rated output current	Per output: max. DC 0.25 A Total: max. DC 0.5 A		
Inductive loads	Yes		
High level	DC 24 V (± 5%) RON = 200 mΩ		
Low level	< DC 1 V		

13.4 Display with infra-red interface

Display	7-segment LED, 4-digit
Infra-red angle of incidence	± 16°
Infra-red transmission range	1 m
Infra-red type	IRDA standard
Infra-red transmission rate	62.5 kbit/s
Infra-red transmission mode	bi-directional, half-duplex

13.5 Cable lengths and specifications

Connection between:		Cable length ^A	Specification ^A
Vehicle control system	EMS rail L1, L2, L3, PE	≤ 3 m	1.5 ... 2.5 mm ² flexible
	EMS rail S1, S2, S3, S4		
	Motor	≤ 3 m	1.5 ... 2.5 mm ² flexible
	Sensors	≤ 5 m	≥ 0.35 mm ² flexible, shielded
	Vehicle PE		≥ 2.5 mm ² flexible

^A Recommended

13.6 Approvals and standards

Conformity

Devices made by Conductix-Wampfler Automation GmbH have been designed to comply with EU directives. Please contact Conductix-Wampfler Automation GmbH if you wish to obtain a copy of the EU Declaration of Conformity.

Certifications Controllers of the types ST-83x / ST-84x are tested and certified as follows:

Tested according to	EN 61800-5-1:2007/A1:2017
Certificate number	B 063502 0032
Certification body	TÜV Süd Product Service GmbH
Certification mark	

13.7 Device drawing

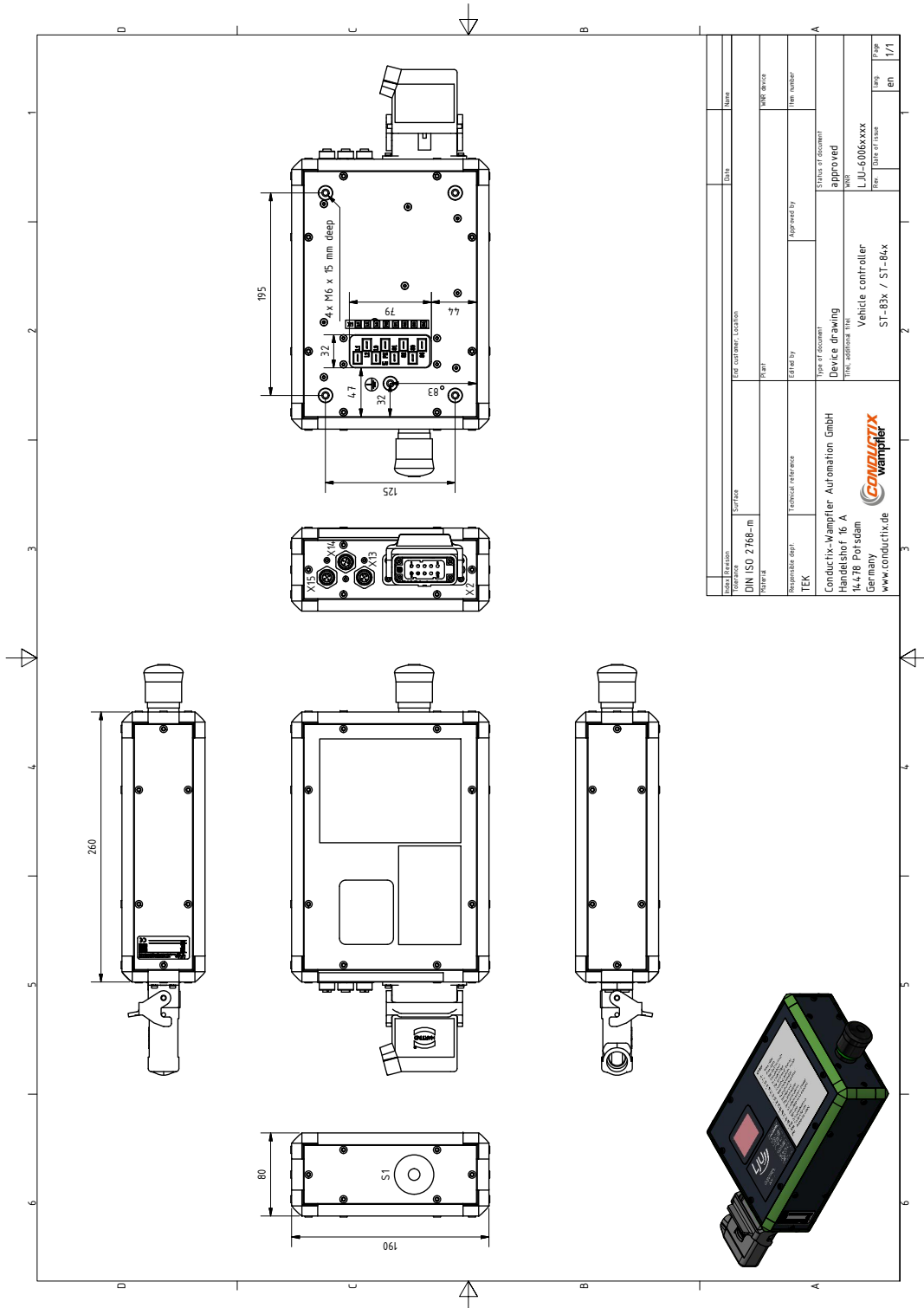

Fig. 15: ST-83x/ST-84x device drawing

14 Customer service and addresses

Customer service

Our service team is available to provide technical information.

■ **Conductix-Wampfler Automation - Service**

Phone: +49 331 887344-15 | Fax: +49 331 887344-19

E-mail: service.potsdam@conductix.com



Service forms

Service forms are available for download under www.conductix.com.

Please send completed service forms to service.potsdam@conductix.com.

Further contacts

Conductix-Wampfler Automation GmbH

Handelshof 16 A | 14478 Potsdam | Germany

Phone: +49 331 887344-0 | Fax: +49 331 887344-19

E-mail: info.potsdam@conductix.com | Internet: www.conductix.com

■ **Conductix-Wampfler Automation - Sales**

Phone: +49 331 887344-02 / -04 | Fax: +49 331 887344-19

E-mail: sales.potsdam@conductix.com

■ **Conductix-Wampfler Automation - Service**

Phone: +49 331 887344-15 | Fax: +49 331 887344-19

E-mail: service.potsdam@conductix.com

■ **Conductix-Wampfler Automation - Repairs**

Phone: +49 331 887344-615 | Fax: +49 331 887344-19

E-mail: repair.potsdam@conductix.com

Conductix-Wampfler GmbH

Rheinstrasse 27 + 33 | 79576 Weil am Rhein | Germany

Phone: +49 7621 662-0 | Fax: +49 7621 662-144

E-mail: info.de@conductix.com | Internet: www.conductix.com

For further addresses of sales and service locations, visit:

- www.conductix.com

15 Index

A

Addresses.....	107
Applicable documents.....	8
Automatic mode.....	74, 81

C

Cable lengths and specifications.....	103
Capacitive load.....	42
Certifications.....	104
Cleaning.....	92
Clearance.....	32
Compensation.....	27
Configuration switch.....	58, 60
Configuration table.....	60
Conformity.....	103
Cooling.....	32
Customer service.....	107

D

Damage in transit.....	27
Device drawing.....	105
Display modes.....	78
Displays	
Error displays.....	85
Operation displays.....	77
Display with infra-red interface.....	76

E

Earth.....	41
Electrical connection	
Connection overview.....	45
X13, X14, X15 connection.....	49
X1 connection.....	46
X2 connection.....	48
Electromagnetic compatibility.....	41
EMC requirements.....	41
EN 61800-5-1.....	21
Error reset.....	87
Errors to be acknowledged.....	88
Error types.....	87

F

Fixing points.....	34
Fuse protection.....	40

G

Grid feed.....	43
----------------	----

I

Infra-red interface.....	76
Installation.....	34
Installation location.....	33
Installation position.....	33

L

Layout.....	24
-------------	----

M

Maintenance.....	17, 91
manual mode.....	81
Manual mode.....	74
Manual reset.....	88
Messages.....	85

O

Operation.....	17, 91
----------------	--------

P

Parameter.....	58
Parameter values.....	55, 58
PCM time delays.....	69
PE connection.....	43, 50
Personnel.....	16
Power-on reset.....	89
Protective earthing.....	43
Pulse brakes.....	69

Q

Qualification.....	16
--------------------	----

R

Regenerative braking.....	69
Remote control.....	80
Moving using the hand-held remote control.....	83
Moving with the manual programming device.....	83

Residual current circuit breaker (RCCD)....	40	U	
Responsibility of the operator.....	15	Unrestrained manual mode.....	74, 81
Responsible party		Use for intended purpose.....	14
Commissioning.....	51	V	
Electrical installation.....	37	Vehicle parameters.....	60
Installation.....	29	Vehicle tables.....	60, 61, 62
Operation.....	71	W	
S		Warranty.....	9
Safe isolation.....	21		
Safety			
Operation.....	71		
Safety notes.....	11		
Self-acknowledging errors.....	87		
Storage.....	28		
Switching off the control system.....	75		
Switching on the control system.....	75		
T			
Technical data			
Ambient conditions.....	100		
Display with infra-red interface.....	103		
Input data.....	101, 102		
Material.....	99		
Output data.....	102, 103		
Sizes and weights.....	99		
Types.....	99		
Test			
Brake.....	64		
Digital inputs.....	66		
Digital outputs.....	66		
Messages.....	67		
Motor functions.....	64		
Motor rotation.....	64		
Motor temperature sensor.....	65		
PCM commands.....	67		
Z-stop.....	67		
Transfer of risk.....	57		
Transport.....	27		
Type label.....	25		
Types.....	25		